

**Catalina** OWNERS  
MAGAZINE

[www.mainsheet.net](http://www.mainsheet.net)

VOL. 36, NO. 4  
WINTER 2018

# MAINSHEET



Australia to the  
**SEYCHELLES**

**SCHAEFER**  
LEGENDARY STRENGTH



# The Best of Both Worlds

Schaefer's Patented articulating mast track enables you to reef or furl on any point of sail from the safety of the cockpit. Enjoy a fully battened sail that doesn't compromise performance for safety. The Best of Both Worlds!



Learn More from Our Video Gallery  
@ SchaeferMarine.com



The perfect alignment between the articulating Luff Track and gooseneck is made possible by our computer machined aft furling drum. Machining details allow us to place Torton™ ball bearings in each end fitting reducing friction.

Details make the difference. Machining our goosenecks from 6061-T6 aluminum ensure strength and reliability for years of trouble free service.

**SCHAEFER**  
LEGENDARY STRENGTH

508.995.9511

SCHAEFERMARINE.COM

# MAINSHEET

WINTER 2018

Volume 36 • Number 4

## COLUMNS:

**7** **SAFE JOURNEY**  
BY DAVID ALLRED [C320]

**9** **VIEW FROM THE BRIDGE**  
BY FRANK FALCONE [C400/445]

**11** **LESSONS LEARNED**  
BY KEN JUUL [C34]

## COVER STORY:

**12** **AUSTRALIA TO THE SEYCHELLES**  
In 2009 at the age of 40, I decided to take a three month sabbatical and cruise up the east coast of Australia. That three month sabbatical has now been going on for nine years...

## FEATURES:

**14** **WHAT LIVING SHOULD BE ABOUT**  
TIKI has already changed our lives. The stressors of life are still there, but when we are sailing – sails filled, engine quiet and all we can hear are the waves lapping against her hull – those stressors lessen...

**16** **JACK HEADS TO ALASKA SE**  
As I prepared for the trip I began to realize how totally different the considerations for a blue water adventure like the Transpac were when compared to the coastal cruising I would be doing...

**19** **CELEBRATING THE CORONADO 15**  
At the 2017 Coronado 15 North American Championship competitors, officials and volunteers took part in celebrating the 50th anniversary of the launch of the first Coronado 15 high performance sailing dinghy...

## TECH NOTES:

**20** A *Mainsheet* exclusive! Technical information for your boat that has been approved by Catalina Yachts for accuracy.

## ASSOCIATION NEWS:

**40** Stories and news that's specific to your Catalina sailboat.



12



16



44

## EDITORIAL:

CATALINA MAINSHEET (ISSN 1527-9073) is published quarterly by Eagle LTD. 3504 Amberley Trail, Evans, GA 30809. Periodical postage paid at Evans, GA 30809, and additional offices.

**Managing Editor**  
Frank Butler  
President Catalina Yachts

**Publisher / Editor**  
Jim Holder  
3504 Amberley Trail  
Evans, GA 30809  
Phone (706) 951-4282  
Fax (706) 651-0533  
cv.jholder@mainsheet.net

**Associate Editor**  
Carol VandenBerg  
3504 Amberley Trail  
Evans, GA 30809  
Phone (706) 951-4282  
Fax (706) 651-0533  
carol@mainsheet.net

**Technical Editor**  
Gerry Douglas  
Designer & Engineer  
Catalina Yachts  
gerard@catalinayachts.com

Technical articles published herein are the advice and opinion of the individual author solely. Catalina Yachts, Catalina Mainsheet and/or the National Associations are not liable or responsible in any way for their contents or consequence.

## SUBSCRIPTION INFORMATION:

SUBSCRIPTION to Catalina Mainsheet is available through payment of your Association dues.  
**See page 4 for details.**

## MOVING?

**POSTMASTER:**  
Send address changes to Catalina Mainsheet, 3504 Amberley Trail Evans, GA 30809

**SUBSCRIBERS:**  
Send address changes to your association.  
See page 4 for addresses.

## ADVERTISING:

**To reserve advertising space contact**  
Jim Holder  
3504 Amberley Trail  
Evans, GA 30809  
Phone (706) 951-4282  
Fax (706) 651-0533  
cv.jholder@mainsheet.net

Advertisement of items in Catalina Mainsheet does not imply endorsement by National Associations.

## PRODUCTION:

 **landisproductions**<sup>LLC</sup>

1911 Huguenot Road  
Suite 301  
Richmond, VA 23235  
(804) 897-0495 phone  
email:  
david@landisproductions.com  
website:  
www.landisproductions.com

# Share Your Stories with Us!

**Mainsheet is the official magazine of Catalina Yachts sailboat owners — read by thousands around the world.**

To submit association news or tech notes for publication in *Mainsheet* magazine, contact the appropriate association officer for your boat size listed below. Your article might be selected as a main feature or an editorial column, so please consider including a few beautiful photos to accompany your text!

## SUBMISSION DEADLINE DATES TO YOUR ASSOCIATION:

March 1st, June 1st, September 1st and December 1st.

### International All Catalina Alliance

Association News & Tech Notes: Donna Ferron, 484-678-4592, donnarferron@verizon.net

### Catalina 470 National Association • [www.catalina470.org](http://www.catalina470.org)

Association News: Julie Olson, (650) 504-5304, voyagerC470@yahoo.com  
Tech Notes: Joe Rocchio, jjr.onward@gmail.com

### Catalina Morgan 440 National Association • <http://catalina440.org>

Association News: Jessie Mackelprang-Carter, sv.thredthread@gmail.com  
Tech Notes: Mike Simpson, mike@threesheetssailing.com

### Catalina 42/425 National Association • [www.catalina42.org](http://www.catalina42.org)

Association News: Ken Fischer, 503-473-7252, catalina42@mac.com  
Tech Notes: Gene Fuller, gefuller42@comcast.net

### Catalina 400/445 International Association • [www.catalina400.org](http://www.catalina400.org)

Association News: Martha and Dan Bliss, 717-676-7635 (cell), sailbrunelle@gmail.com  
Tech Notes C400 Hulls: Olav N. Pedersen, 713-907-3301 (cell), olavnp@gmail.com.  
C445 Hulls: Position Open

### Catalina 380/385/387/390 Int'l Association • [www.catalina380.org](http://www.catalina380.org)

Association News: Kathy Ahillen, kahillen@comcast.net  
Tech Notes C380, C390 Hulls: Michael Gilmore, mggilmorern@gmail.com  
C387 Hulls: Tom Brantigan, Tbrantigan@verizon.net  
C385 Hulls: Chuck Couture, Clcouture@ymail.com

### Catalina 38 International Association • [www.catalina38.org](http://www.catalina38.org)

Association News: Chuck Finn, (518) 226-0584, charles@finn.ws  
Tech Notes: Steve Smolinske, SSmolinske@rainierrubber.com

### Catalina 36/375 International Association • [www.c36ia.com](http://www.c36ia.com)

Association News: Lauren Nicholson, lauren@nicholsonmarine.com  
Tech Notes C36 Pre Mk II Hulls: Leslie Troyer, leslie@e-troyer.com  
C36 Mk II Hulls: Chic Lasser, chiclasser1@yahoo.com  
C375 Hulls: Position Open

### Catalina 350 International Association • [www.catalina350.com](http://www.catalina350.com)

Association News: Bruce MacGregor Whyte, association\_editor@catalina350.com  
Tech Notes: Bill Templeton, pbtemp6816@verizon.net

[www.mainsheet.net](http://www.mainsheet.net)

*Mainsheet* magazine is also available as a password-protected digital download in PDF format so you can print specific pages for archiving in your boat's 3-ring binder or for easy reading on your favorite digital devices. Download this issue today!



## EDITOR'S BARQUE

### The People We Meet

In the sailing world, as we go through life, we encounter thousands of people, some of whom can have a significant influence on us. Allen and Elsie Elliot were two such people. They were a sailing family, including all the children. They started with a C15 and eventually reached a C36. Their enthusiasm for the sport was contagious as they constantly reached out to everyone to share their love of sailing.

Carol and I had many happy and exciting experiences sailing the waters of Southern California with them over the years, including the Ensenada race from Newport Beach, California, to Mexico. This is one of the most well attended big boat regattas in the area. For me, being a strictly dinghy racer, getting on the line with all those heavy hitters was, shall we say, a little intimidating but extremely exciting.

Allen passed several years ago and Elsie recently, but their support and love of sailing that they shared with others will last forever.

– Jim Holder

Publisher/editor  
[cv.jholder@mainsheet.net](mailto:cv.jholder@mainsheet.net)

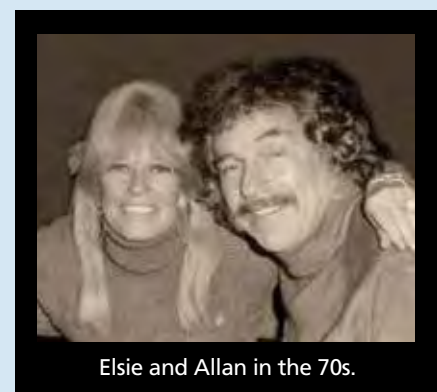

Elsie and Allan in the 70s.

#### **Catalina 34/355 International Association • [www.c34.org](http://www.c34.org)**

Association News: Jack Hutteball (Fleet 5), [jhuttebalL@comcast.net](mailto:jhuttebalL@comcast.net)

Tech Notes: John Nixon, [c34hull728@gmail.com](mailto:c34hull728@gmail.com)

(Associate Technical Editor): Ron Hill (Fleet 12), [ronphyllhill@comcast.net](mailto:ronphyllhill@comcast.net)

#### **Catalina 320 International Association • [www.catalina320.com](http://www.catalina320.com)**

Association News: Rod Boer, 215-675-8286, [rod.boer1@verizon.net](mailto:rod.boer1@verizon.net)

Tech Notes: Warren Updike, [wupdike@hotmail.com](mailto:wupdike@hotmail.com)

#### **Catalina 310/315 International Association • [www.catalina310.org](http://www.catalina310.org)**

Association News: Bob James, 614-481-6744, [bob@advancedreading.com](mailto:bob@advancedreading.com)

Tech Notes: Jesse Krawiec, [jessek65@gmail.com](mailto:jessek65@gmail.com)

#### **Catalina 30/309 International Association • [www.catalina30.com](http://www.catalina30.com)**

Association News & Tech Notes: Max Munger, [maxmunger@verizon.net](mailto:maxmunger@verizon.net)

#### **Catalina 28 International Association • [www.catalina28.net](http://www.catalina28.net)**

Association News: Dave Brower, 949-278-0926(H), [browerd@comcast.net](mailto:browerd@comcast.net)

Tech Notes: Ken Cox, [kenneth\\_cox@sbcglobal.net](mailto:kenneth_cox@sbcglobal.net)

#### **Catalina 27/270 International Association • [www.catalina27.org](http://www.catalina27.org)**

Association News: Peter Zahn, 410-431-5045, [Peter.zahn@gmail.com](mailto:Peter.zahn@gmail.com)

Tech Notes C27 Hulls: Judy Blumhorst, [judyb@hydesailsUSA.com](mailto:judyb@hydesailsUSA.com), 925.997.0786

C270 Hulls: Phil Agur, 530-677-6229, [pjagur@sbcglobal.net](mailto:pjagur@sbcglobal.net)

#### **Catalina 26 National Association • [www.members.tripod.com/capri26](http://www.members.tripod.com/capri26)**

Association News: Position Open

Tech Notes: Position Open

#### **C25/250 & Capri 25 Int'l Association • [www.catalina-capri-25s.org](http://www.catalina-capri-25s.org)**

Association News: Brian Gleissner, [mainsheet@catalina-capri-25s.org](mailto:mainsheet@catalina-capri-25s.org)

Tech Notes C25 Hulls: Seth Martin

C250 Hulls: David Gonsalves, [catalina250tech@catalina-capri-25s.org](mailto:catalina250tech@catalina-capri-25s.org)

Capri 25 Hulls: Position Open

#### **Catalina 22 National Association • [www.catalina22.org](http://www.catalina22.org)**

Association News: Rich Fox, 317-815-8599, [rich\\_fox@yahoo.com](mailto:rich_fox@yahoo.com)

#### **Catalina 15 National Association**

Association News: c/o Mainsheet, [cv.jholder@mainsheet.net](mailto:cv.jholder@mainsheet.net)

**Visit the association's websites for full lists of association officers.**

## ABOUT OUR COVER:

*Photo by Rik Soderlund of Sukha, a C470 at Cocos Keeling atoll in the middle of the Indian Ocean.*

**Membership  
has its  
benefits!**

## Join an Association or Renew Your Membership

**Association members enjoy a wealth of benefits to make the most of your sailboat purchase, including a subscription to *Mainsheet* magazine!**

Associations are designed to enhance the enjoyment of owning a Catalina in a number of ways. They are composed of members worldwide who are all committed to Catalina sailboats and seek the camaraderie and support of like-minded individuals. Members include racers, cruisers, weekenders, hobbyists, and all manner of Catalina sailors. In areas where many Association members live near each other, Associations often help facilitate local fleets, whose local participants support one-another and encourage participation in local events and activities. Visit your boat's Association website today to learn more!

**Contact your association directly to join an association or to renew your membership. If you are paying by check, make it payable to your Association.**

**Catalina 470**  
**[www.catalina470.org](http://www.catalina470.org)**

Catalina 470  
c/o PO Box 4003  
Roanoke, VA 24015  
Annual Dues: \$25 (US Funds)

**Catalina Morgan 440**  
**[Catalinamorgan440@gmail.com](mailto:Catalinamorgan440@gmail.com)**

John McElderry  
20660 Hope Spring Terrace  
Unit 406  
Ashburn, VA 20147  
Annual Dues: \$30

**Catalina 42/425**  
**[www.catalina42.org](http://www.catalina42.org)**

Catalina 42  
c/o PO Box 4003  
Roanoke, VA 24015  
Catalina 42 Annual Dues: \$25  
Two years: \$45 US  
Three years: \$65 US  
Catalina 425 Annual Dues: \$30  
Two years: \$50 US  
Three years: \$80 US  
(US Funds)

**Catalina 400/445**  
**[www.catalina400.org](http://www.catalina400.org)**

Catalina 400/445  
c/o PO Box 4003  
Roanoke, VA 24015  
Annual Dues: \$25

**Catalina 38**  
**[www.catalina38.org](http://www.catalina38.org)**

Bob Kirby  
Annual Dues: Mail \$25.00;  
Credit Card \$26.00

**Catalina**  
**380/385/387/390**  
**[www.catalina380.org](http://www.catalina380.org)**

Bob Goldman  
98 Rockledge Drive  
Pelham Manor, NY 10803  
Annual Dues: \$25  
Two years: \$48  
Outside US: \$35 (US funds)  
Outside US two years: \$68  
(US funds)

**Catalina 36/375**  
**[www.c36ia.com](http://www.c36ia.com)**

Membership  
Hal Baker  
135 Greenbriar Court  
East Peoria, IL 61611  
bakerha81@gmail.com  
Annual Dues: \$35  
Three Years (includes CD): \$95  
Supporting Member  
(no Mainsheet): \$25

**Catalina 350**  
**[www.catalina350.com](http://www.catalina350.com)**

Catalina 350  
c/o PO Box 4003  
Roanoke, VA 24015  
Annual Dues: \$25

**Catalina 34/355**  
**[www.c34.org](http://www.c34.org)**

Stu Jackson  
925 Cherry Point Road  
Cowichan Bay, BC, Canada  
VOR 1N2  
Annual Dues: \$25  
Two years: \$45

**Catalina 320**  
**[www.catalina320.com](http://www.catalina320.com)**

Catalina 320  
c/o PO Box 4003  
Roanoke, VA 24015  
Annual Dues: \$30

**Catalina 310/315**  
**[www.catalina310.org](http://www.catalina310.org)**

Curt Sawyer  
287 E. Highland Ave.  
Atlantic Highlands, NJ 07716  
Annual Dues: \$24  
All Others: \$28 (U.S. Funds)

**IC30A/309**  
**[www.catalina30.com](http://www.catalina30.com)**

IC30A  
c/o PO Box 4003  
Roanoke, VA 24015  
Annual Dues: \$30 US / \$35 Other  
Two Years: \$55 US / \$65 Other  
Associate Member/  
No Mainsheet: \$15 US

**Catalina 28**  
**[www.catalina28.net](http://www.catalina28.net)**

Catalina 28  
c/o 1075 Klem Road  
Webster, NY 14580  
Annual Dues: \$20  
Canada/Mexico \$24 (US Funds)  
All others \$27 (US Funds)

**Catalina 27/270**  
**International**  
**Association**  
**[www.catalina27.org](http://www.catalina27.org)**

Catalina 27/270  
c/o PO Box 4003  
Roanoke, VA 24015  
ic27a@sbcglobal.net  
Annual Dues: \$25  
Canada/Mexico: \$30 (US funds)  
All others: \$30 (US funds)

**Catalina 26**  
**[www.members.tripod.com/capri26](http://www.members.tripod.com/capri26)**

Mark Shockey  
10513 Wallingsford Circle  
Dayton, OH 45458  
Annual Dues: \$26  
All others: \$26 (US funds)

**Catalina 25/250 & Capri 25**  
**[www.catalina-capri-25s.org](http://www.catalina-capri-25s.org)**

Catalina 25/250 & Capri 25  
c/o PO Box 4003  
Roanoke, VA 24015  
Annual Dues: \$22  
All others: \$28 (US funds)

**Catalina 22**  
**[www.catalina22.org](http://www.catalina22.org)**

Dora McGee  
3790 Post Gate Drive  
Cumming, GA 30040  
Annual Dues: \$39.00  
Associate Member/  
No Mainsheet Dues \$25.00

**Catalina Owners**  
**without**  
**Organized Association**

c/o IACA Members  
PO Box 9207  
Fayetteville, AR 72703  
Annual Dues: \$15



**YANMAR**

# YANMAR JH-CR SERIES

40 - 45 - 57 - 80 - 110 MHP



YANMAR is proud to be the exclusive engine provider to Catalina Yachts for over 20 years.

**5x**  
**BEST IN CLASS**



**Clean**



**Interconnective**

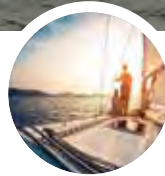

**Quiet**

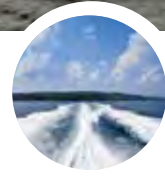

**Powerful**



**Fuel Efficient**



## **JH-CR Series**

**The global standard for sailboat propulsion.**

YANMAR's new generation JH-Common Rail Series, with class leading features, out performs its competition. Compact, powerful, smooth, quiet, efficient and interconnective, the JH-CR Series is perfect for any application whether rib, tender, sailboat or catamaran, new or re-power.

With over a 100 years of innovation, unequalled reliability, and the largest marine engine global service network, choosing a YANMAR ensures you will enjoy many safe and carefree years on the water.

# SOLAR ON THE BIMINI...



## **SOLARFLEXX PANELS SNAP TO YOUR CANVAS!**

***Complete SolarFlexx Packages from 30 to 660 watts,  
for easy Do-It-Yourself installations!***

**Ferris**  
POWER PRODUCTS



**\* NEW \*  
PowerBoost 30  
MPPT Solar  
Charge Controller**

**HAMILTON FERRIS CO - POWER PRODUCTS**

[www.hamiltonferris.com](http://www.hamiltonferris.com)

508-743-9901

# PROVIDES POWER TO SPARE!

*Safe Journey:*

# An Un-Handyman's Success

By David Allred, Commodore • C320

My father owned a furniture store as I grew up. My brother and I both began working there at an early age. Among the many tasks we undertook were assembling, moving, and installing various electronics and appliances.



From time to time, my father would watch us while we worked. One day, not too long after we started working at the store, Dad watched my brother and me doing some routine chore involving tools and manual skills. After a few minutes, he pulled me aside and said, "Son, there are a lot of ways to make a living once you grow up. None of them is necessarily better than any of the others. But, I've watched you for a while, and I have some advice

for you. You need to do the very best you can in school. I mean, study hard and learn all you can from those books so that you can get a job working at something that does not require any manual skill. Because the best I can tell from what I have seen is that if you have to rely on your mechanical skills, unlike your brother, you will surely starve, go to prison, or accidentally kill yourself before you're old enough to vote or drink whiskey legally, and any of those outcomes would be a terrible shame." He was right, of course (as dads so often are), and the intervening fifty plus years since his thoughtful observation have not seen any significant improvement in my DIY skills.

I say this as a prelude to my undertaking last summer to change the mixing elbow on Romance. When the boat

was hauled last winter, the boat yard advised me that the exhaust elbow had a small leak. After carefully examining the situation, I decided that I probably could do the repair myself. And here is where the book-learning came in handy. First, I went to the C320 website and read all the threads dealing with exhaust elbows. The trove of information and advice was invaluable to an un-handyman. By the time I finished reading all the threads and looking at all the pictures and descriptions posted by those who had done the job before me, I felt confident. But the icing on the cake, so to speak, was the Tech Notes article that appeared in the Summer 2018 *Mainsheet* detailing Danny Jensens's replacement of his mixing elbow. The magazine arrived on the very day I had decided to start the project. His advice about using a vice at home to configure the new assembly was spot on (as an un-handyman, I don't have a vice at home, but my next door neighbor does) and saved hours of frustrating and fruitless work. I also would have likely overlooked the need to use a gasket scraper and high temp anti-seize compound. The upshot of all my research and all the help the C320 association members gave me was a successful project that would probably even impress my dad. All I can say is, Thanks, C320 members for making our association such a valuable part of being a C320 owner.

As an aside, I followed my dad's advice and had a successful and rewarding career working with a pen rather than a wrench or hammer. My brother worked with my father in the furniture business for many years and then worked at a marina as a boat mechanic. We are both retired now and could not be happier with the careers we chose. I think my dad would be happy, too,—and relieved.

"Son, there are a lot of ways to make a living once you grow up. None of them is necessarily better than any of the others..."



HEADSAIL FURLERS · MAINSAIL FURLERS

This boat  
has a furler,  
does yours?



CDI has been involved in the sailing industry for over four decades. We stand firmly behind our products, and with unprecedented reliability our furling system will save you time and money. Backed by our comprehensive warranty, you will have peace of mind and more days on the water. Visit [Sailcdi.com](http://Sailcdi.com) and sail away with ease.

photo by @mikeydetemple

  
CRUISING DESIGN  
INTERNATIONAL

View from the Bridge:

# Boat Yoga

By Frank Falcone • C400/445

**Sailing past 70**

...no not past latitude 70 degrees and, most certainly, not past 70 knots! We're talking about age - years - the numerical measure of our time here aboard Mother Earth. I recall my Mom telling me that life's downward slope starts getting pretty steep after 65. For the mathematical types out there, that means that the *dy/dx* starts to increase dramatically after age 65. At 70 it starts to look vertical! OH NO! But,



is that some sort of mathematical certainty? I think not! So, here I am wading through the early years of my 7th decade wondering what's next (other than the inevitable). ... the answer - more sailing of course!

We Baby Boomers are continually bombarded with Radio, TV, Internet, and Snail Mail advertisements telling us how to secure a safe financial retirement.

In addition to those non-ceasing reminders we are also deluged daily with travel brochures showing us pictures of sunsets, mountains, blue seas, hotel rooms, glasses of white wine and sumptuous dinner plates. Why are we receiving all of this? Because we have a few bucks and they want them. I suppose that if we faithfully followed these advertisements we'd dutifully relinquish our funds to those advertisers, spending them on never ending trips, airplane rides, structured luggage management, and pricey excursions. And, oh the calories! Save a few of those bucks for diet control plans and weight related doctor bills!

A cruise now and then is fine, I think. We've done them. However, a steady diet of such trips will, most assuredly, quickly deplete retirement funds and quickly increase girth.

Owning a boat is not a cheap alternative either, as most of us know. However, at least your own mind is in control, not that of a Cruise Director, and your own creativity and innovation are at 'center stage'! You're not being 'herded'. You're the Skipper of our own boat!

I've been thinking quite a bit these days about what's next. If we're fortunate enough to have reasonably good health into our 70s and beyond, let's keep on doing what we like to do. So many of us in our 70s seem to, subliminally, fall into the trap of lethargy, complacency and surrender. Why? Let's never give up!

I'll be the first to admit that complacency is hard to fight off. I need to work at it on a daily basis! Waxing the deck, fixing the toilet, repairing the dodger and taking the sails off at the end of the season seem to get more difficult with advancing age, not to mention installing the boat cover in mid-December on the Chesapeake Bay – brrrrrrrrrrrrrrrrrrrr!

A sailing friend of mine recently referred to such activities as 'boat yoga'. Terrific! Forced yoga exercise is provided with boat ownership! How lucky we are. Yoga without having to go to yoga class!! These are precisely the types of tasks that we should try to continue to do to 'stay young'. Staying young means not giving in to what others think we should do in our 70s. It means, 'keep on keepin' on!'

Our boats are our 'youth capsules'. If we surrender them in order to increase the value of our retirement funds or to buy single floor condos in Florida with flat screen TVs in every room, we may have traded our 'youth capsules' in for two-toned, naugahyde electric (2 speeds at least) recliners. Hmmmm, they do sound comfy, don't they? ...nope, clear these out of my head! ...not going there!

Sailing into our 70s and beyond keeps our minds and bodies sharp (or should I say 'less dull'?). It gives us opportunities to discover new destinations not shown on the endless trail of travel brochures and provides a continual opportunity for us all to 'talk boats' with like-minded friends and colleagues. Who knows what tomorrow will bring? The older we get, the more dense and foreboding the path ahead may become if we choose to let it be such. For now, for those of us in, near or beyond our 70s, let's brush off the dense path ahead and let's find ways to say 'YES' to more sailing. In the long run (how ever long it is), we'll be the better for it. To possess youth is to possess an open and inquiring mind. It's not an 'age thing'. It's a 'mind thing'! Sailing gives us that opportunity each time we board our 'youth capsules' to stay young.

"Sailing takes me away". Hmmmm, it seems like I heard that once in a song when I was younger. Since I'm still in my youth, when was that?

Frank Falcone is Commodore of the C400/445 International Association, a retired Captain, USN, and a registered U. S. Coast Guard Captain (6 Pax)

Regarding SAILING PAST 70, if any of us need a true Role Model, perhaps that individual could be Mr. Jean-Luc Van Den Heede. Mr. Van Den Heede is currently racing in the Golden Globe Race. This is a solo, single-handed, non-stop, around the world race aboard fiberglass sailboats between 32' and 36' in length with no modern electronics. The expected duration of this race is about 330 days. This race started on July 1, 2018 and, as of September 10, 2018, Mr. Van Den Heede is in 1st position. He is 73 years young! Stay at it and stay safe out there!



**Catalina**  
**Yachts Store**  
CatalinaYachtsStore.com



**\$10 OFF YOUR NEXT  
PURCHASE OF \$100 OR MORE  
WITH DISCOUNT CODE  
MAINSHEET18**

PERSONALIZED APPAREL & MATS // CUSTOM FITTED SHEETS // INTERIOR & COCKPIT CUSHIONS  
GALLEY ACCESSORIES // SAILING HARDWARE & MORE!

**CatalinaYachtsStore.com**

*Lessons Learned:*

# Getting Your Captains License

By Ken Juul • Past C34 Commodore



---

My three experienced instructors were fonts of knowledge, punctuating lessons with practical experience and were more than happy to listen to experiences of the students if it highlighted the lesson.

---

I just want to add to Laura Olsen's great article about obtaining your Captains License a few issues ago. After watching a dock-mate study with the author driving three hours each way to an authorized testing location 3 times before he finally passed, I decided a school was the way to go.

The school truly is a learning or re-learning experience. My three experienced instructors from "The Captains School" in Cape Coral were fonts of knowledge, punctuating lessons with practical experience and were more than happy to listen to experiences of the students if it highlighted the lesson. The Coast Guard regulates these schools, reviews and approves the curriculum, and requires a minimum number of class hours. Some schools schedule on several weekends, some schools lump the classes together 4-5 days in a row, usually over a weekend.

The course and test are divided into 4 areas; Rules of the Road, Chart Plotting, General Navigation, and Deck/Safety. Rules of the Road is the most stringent, you must get at least a 90% to pass, and the other areas require 70% to pass.

Mnemonics are spread throughout the course to help you remember details. True Virgins Make Dull Companions (true course +/- variation = Magnetic +/- Deviation = ships compass course. Add west Variation and Deviation, (subtract east) used to convert true courses from from the chart to magnetic courses to steer or magnetic sights to true lines of position on the chart. Another is Red over Red the Captain is Dead, light and flag signal to indicate a vessel not under command. White over Red Pilot (vessel) ahead, etc.

As an endorsement to my OUPV (Operator of un-inspected passenger vessel) also known as a 6 Pax, I also took the towing course. I hope that I never need to use it, but a story was related by the instructor that while living in the Virgin Islands he and several other boaters started salvaging boats after a hurricane. Because he had the towing endorsement, he got paid by the insurance companies, others without it did not.

Another great benefit of the school, is they will help with the paperwork, have all the forms necessary and know where to go for the CPR instruction, drug testing, physicals, etc. Most will QA your forms before submittal to the CG. Probably one of the hardest forms to complete is the sea time form. You need a minimum of 360 days on the water on cruises of at least four hours. Ninety of those days must be in the last three years. You must provide the registration number of each boat that you acquired the sea time on.

The license is only good for 5 years. When it comes time to renew, most schools will help you with that for a small fee. If you are in Florida, I can highly recommend "The Captains School" in Cape Coral. They also have several satellite or traveling schools around the state. Contact the school for details.

An aerial photograph of a tropical island with turquoise water and a sailboat. The island is lush with green vegetation and has a small pier extending into the water. A white sailboat with a blue stripe is anchored in the clear, shallow water. The sky is blue with some light clouds.

# Australia to the SEYCHELLES

In 2009 at the age of 40, I decided to take a three month sabbatical and cruise up the east coast of Australia. That three month sabbatical has now been going on for nine years. At the end of that first three months I rang my partner Sophia and told her she was fired (she worked in my business). It was best that she pack her bags, hop on a bus and join me on the boat, because I'm not coming back. Sophia has been part of the adventure since then; she may not always use the word adventure...lol."

Six of those years we cruised in SE Asia. It ruined me. In 2016 while cruising up the west coast of Sumatra I realized I couldn't go back to "normal" and it was time to buy a bigger boat and head further west.

I didn't want an old design, yet I wasn't convinced that all of the modern production boats were designed sturdy enough for the type of cruising we do. A very knowledgeable surveyor friend suggested the Catalina C470. It happened very quickly from there, there was one for sale an hour from where my home was in Australia. It was a 2002 model #87, 830 hours on the engine and in my price range. I made a cheeky offer that to my surprise was accepted and within a week I was the proud owner of an immaculate Catalina C470.

This was December 2016. I gave myself three months to get Sukha (previously EinSof) ready to cross the Indian Ocean. She was in great condition but had basically nothing on her, not a spanner, not a jerry can or any of prerequisites required for cruising. I changed her rigging, added an Atlantic arch, 500 watts of solar, a

large capacity water maker, a Hydrovane, and every tool known to man.

At this stage I'd only sailed 80 nm on her; I figured we'd get to know each other on the way. The end of March 2017 we took off up the east coast of Australia. Although I hadn't sailed home waters for many years, I knew this coast, thus could just concentrate on the boat. From the Gold Coast to the top of Cape York is approximately 1600 nm; it's also one of the best sails you can do. A lot of it is inside the Great Barrier Reef, which means flat water and steady consistent SE trade winds of 20-25 kts off the starboard quarter. I soon realised Sukha was quite a fast cruising boat.

We checked out of Australia at Thursday Island, right at the very top of Queensland. Across the top of Australia is very remote, yet you're never alone. Borderforce flies over every day and gives you a call on the VHF. They will find you every single day, no exception. First stop is Ashmore Reef 1,200 nm west. It's Australian territory, yet only 70 nm from Indonesia. I found Ashmore Reef a bizarre stop. Keep in mind that I've stopped in a number of remote reef systems in places like Papua and the Philippines in my travels before. The norm is, charts are very inaccurate, no navigational aids whatsoever, and approach the reef at the speed you wish to hit it.

Ashmore Reef is so Australian, with a massive Borderforce ship that looks like something out of a Batman movie stationed there. They contact us as we enter the reef system; do you have accurate charts they

---

by Dale Tournier

*"Sukha at Cocos Keeling" photos by Rik Soderlund*

ask? All charts for this reef system are very accurate, not to mention perfectly positioned navigational aids and they talk you in via VHF and guide you to a perfectly maintained mooring. BTW there is nothing here but reef in the middle of nowhere, the nanny state is alive and well! I must say the Borderforce guys we dealt with were really nice, and considering you're so remote you feel confident someone will come to your aid in an emergency.

On we went next to Christmas Island, approximately 1,100 nm west (everything's west from here). A wing on wing fast passage, so far we haven't had a day's motoring. Trade wind sailing, fast and in the right direction, you've got to love it. Christmas Island is described as the Galapagos of the Indian Ocean. It's supported by a phosphate mine, and the population is a third Australian, a third Chinese, and a third Malay. Oh, and it's Australian territory still! Jungle, cliffs, clear water and crazy wildlife, with huge crabs that climb coconut trees to get coconuts! Cruising is often more about meeting people than the places you go, Christmas Island was very much like this. We met some great people and had a fantastic time. We stayed four days with endless amounts of booby birds flying over head (tip: don't let a booby land on your solar panels, let's just say they drink a lot of salt water).

Next stop was Cocos Keeling. You know the photographs of paradise islands on the front of cruising magazines? This is Cocos Keeling, picture postcard perfect. 540 nm WSW of Christmas Island, this atoll is smack in the middle of the Indian Ocean with crystal clear water, thousands of coconut trees and coral. It blows in this part of the world; in fact it doesn't seem to stop blowing. Trying to slow down to make a daylight arrival is hard.

It's an awesome feeling while rocking up to a tropical paradise in the middle of nowhere to be greeted by other cruisers. The camaraderie is a wonderful part of cruising; the bond that comes about from understanding the challenges and discomfort as well as rewards that come from this life instantly connects you, regardless of nationality. What's not cool is entering a coral lagoon with 25 kts blowing. The water is so clear that ten meters seems like two. We had a fantastic four weeks anchored in paradise and now we have to decide which way to go, Rodriguez or the Seychelles via Chagos. We say goodbye to friends and head to the Seychelles.

1500 nm, Chagos here we come. First three days are typical trade wind sailing. Late on the fourth day the wind started building, 25, 30, 35, then sustained 40 kts winds. Eventually it climbed to high forties. I slowly reduced sail as the wind picked up, eventually to nothing and we were running under bare poles averaging 7 kts. We surfed once momentarily at 16.3 kts! To be honest it wasn't that bad, Sukha at no time felt overwhelmed although the seas had built up quite large, with heavy rain and we couldn't see a thing.

For the first time we got a couple of leaks through side hatches, the boat must have been flexing a little in the big swells. Sophia stayed down below and I clipped myself in behind the wheel, chocolate being passed up at regular intervals. My only concern was the autopilot failing (which it didn't). I'd hate to be surfing in those swells and have it let go. By dawn it was calming down and so was I – l.o.l.



I don't know what was more frustrating, the gale or the crazy light winds from the wrong direction for the next four days! Anyway, after 13 days at sea we entered the Chagos archipelago. Remember that picture post card perfect I mentioned earlier, here's another one. It's very remote with only one other boat when we arrived. This is British Indian Ocean Territory; you need a permit to stay there and are limited to one month. I've always wanted to go there, it was a real buzz once anchored to say, "We got to Chagos, go us!" Chagos is high on many cruisers' bucket list.

We had a wonderful five days in Paradise before our last passage of the year, Chagos to Seychelles, an easy 1,000 nm. The winds don't blow as hard in these latitudes, which is good, as long as it blows, which fortunately it did, a lovely steady 15 kts SE all the way. My favorite kind of passage, non-eventful. We would have stayed a bit longer at Chagos but when a good weather window presents itself I don't want to miss it.

We decided Seychelles was a great spot to sit out the southern cyclone season. Sukha had completed her 7,500 nm shakedown cruise and there was stuff I wanted to change and add. Seychelles is a great place to get ready for our next journey south to South Africa. We ended up staying seven months. The beaches are as good as it gets, just perfect, and the greatest thing of all was the fish life. It's the healthiest underwater life I've seen for a very long time, we must have dived 50+ times! When you're not in the water there are beautiful mountain jungle walks to enjoy. It's a small country but truly is paradise, a first world and first class environment. ■



---

*"Scuba Diving in the Seychelles" photo by Dale Tournier*

# WHAT LIVING SHOULD BE ABOUT

BY PAM BROWN • C350



Several years ago, my husband Russell and I stopped sailing our 1977 Morgan 33 Out Island, Ocean Lady. Life, garden, groceries, grading school papers just plain got in the way. Daily we passed Ocean Lady bobbing about in her slip. Two years ago we gave her to my brother when it became obvious we were not going to use her to the extent we should.

Soon after that, Russell was diagnosed with a condition that causes blindness. The only cure was extreme doses of steroids that caused Avascular Necrosis, disintegrating his left hip. The year he had his hip replaced, my father was diagnosed with liver, lung, and bone cancer and passed away and our teenaged grandson was diagnosed with Immune Thrombocytopenic Purpura, an autoimmune condition that causes him to have critically low blood platelets. This triple whammy put life into perspective.

So, I retired from teaching and Russell retired July this year.

We live in the sailors' paradise of Destin, where people come to vacation, and yet Russell and I allowed too many excuses to get in the way of taking advantage of this beautiful place we call home. I began to talk to Russell about buying another cruiser.

Russell is an avid Laser sailor. I had been talking, OK, nagging him about it. I filled many of my days online looking for just such a boat. Every time I found "THE" boat I would call Russell to look it. "Yeah, it's a nice boat" and that would be that.

Convincing him we needed a boat was not easy. He pretty much was not in the frame of mind to find anything to occupy a retirement that hadn't yet happened for him. Also, he simply wasn't sure he wanted the responsibility of a cruiser's upkeep. But, I am nothing if not persistent!

One Saturday morning Russell was sleeping in, I was browsing for a boat. Clicking on a new listing and dozens of pictures, I checked off each of my "must-haves". I yelled "Russell! I found our PERFECT boat!" Crickets. "You have to come see her!" I gave him a back massage while he clicked through the pictures, giving it more than his usual glance. I did not utter a word. I just kept really concentrating on rubbing his back. After 20 minutes, he got up and said, "Yep, that's a nice boat." "That's all? It's a nice boat?". "Yes, it's a nice boat. Have you had breakfast?"

We never talked of the boat again until Monday. Russell came home from work and asked me how my day was. I said, "It was good! I went to the post office, bank, did chores

around the house, got groceries, made dinner, and, rapidly, called the broker about the boat. We are just going to run over on Saturday for a quick look. How was your day?"

He made sure we were just going to "take a quick look at 'it'; NOT go NUTS; He wasn't ready for a boat; and we "are just going to look not buy". Yada, yada, yada. Yes we would just take a look at her. Russell referred to her as 'it', and not the personal "she". I was like, "Okay, okay, I get it".

Monday was raining. I choked up as we walked the dock towards TIKI, a 2004 Catalina 350, hull #154. The clouds parted, and the sun shone down on TIKI. I think I heard a chorus of angels singing. I remembered being cautioned to not go nuts, so I squelched every thought of just that. Russell was holding my hand, squeezing it tightly as if he knew I was about to do something like fall to my knees sobbing while fumbling in my purse for our checkbook.

Our "quick" look turned into two and a half hours. The broker told us everything we didn't even think to ask. There was nothing about TIKI I didn't love. While Russell was talking to him about mechanical and electrical issues (some looked like something from Mission Control at NASA), I was sailing her into crystal clear waters with full sails.

After our "quick look," we lunched at a restaurant next to the marina at a window table, and just stared at her. I tried not to make the entire conversation all about TIKI, but asked Russell repeatedly, "Isn't she beautiful, amazing?" "Don't you just love her?" His response to all my inquiries: "It's a nice boat."

By now, I am sure you're wondering how Russell even puts up with me. We have been together since we were 15, a long time! Really, we are a partnership and make decisions together. It's just that sometimes when he is playing "devil's advocate," I feel it is my job to show him a different side of things, such as "but, on the other hand" response from me!

So, that's what we did, but NOT before I asked for a sign that we should buy TIKI. A few nights after seeing TIKI, and after a few days of hoping for a sign, we were working the daily crossword puzzle and a clue Cruise Vessel came up. I wrote in "SHIP." The next clue was Polynesian Image. I wrote in "TIKI." The next clue was "Blissful Spot." I wrote in "EDEN." This was a pretty unbelievable sign. (Russell would end up telling everyone we know that the crossword puzzle was the point of no return). That crossword puzzle hangs in TIKI's salon as a constant sign that she was meant to be ours.

The day we took ownership of TIKI, Russell's brother and girlfriend came with us for her inaugural 60 mile ICW sail from Pensacola to her new home in Niceville, FL. That day is one of THE top days of my life. Winds were 12-16 knots from the NNW, and we were sailing east. At one point, TIKI reached 8 knots. No words can describe the exhilaration each of us felt. It was a brisk but sunny March day, with tugboats, dolphins in our wake, pelicans atop channel markers, and Osprey helicopters practicing



over-water maneuvers. Each channel marker was met with beautiful and glorious heart-happening moments. TIKI is not our first boat, but she will be our last. She will be the boat to see us through the rest of our sailing days, and she will be the boat to bring back, for us, what living should be about. It is said that boats have a soul, and I believe that of TIKI. That day, sailing her home, she showed us she is strong and proud. She is kind and forgiving. She is comfortable and safe. And while we are still discovering her many secrets, that day she spoke loud and clear, and we listened.

## LOVE IS A CATALINA 350

TIKI has already changed our lives. The stressors of life are still there, but when we are sailing – sails filled, engine quiet and all we can hear are the waves lapping against her hull – those stressors lessen. Our goal is to let her take us on untold adventures to many points on the compass rose. But for now, sometimes we just sail broad reaches back and forth across Choctaw Bay – back and forth, back and forth. Sometimes, when it's time to head back to the dock, Russell and I look at each other, and without saying a word, we tack and head back out to the bay for one last back and forth before calling it a day. Sometimes we never even leave the dock; we may have dinner in TIKI's cockpit and watch the sunset, or tinker with setting and resetting her lines, or piddle with the dinghy (fondly named "Dingh-Bat"), or fiddle with this or that. My late mother-in-law, an avid sailor herself, had a favorite quote from *The Wind in the Willows*: "Believe me, my young friend", said Water Rat, "There is nothing – absolutely nothing – half so much worth doing as simply Messing About in Boats."

On those days when we simply mess about in TIKI, this quote speaks volumes to me.

Looking back, I know we could have, and should have, carved out time to sail Ocean Lady and enjoyed a more balanced and meaningful life. Even though the responsibilities of life will always be present, for now, and until we are no longer able to sail her, TIKI is our means of escaping to a simpler, less complicated way of living, if even for only an afternoon or sunset sail. "Ocean Lady" would be proud. The other day as Russell skippered TIKI via remote control, I asked him, "What are you thinking about right at this moment?" He smiled and said, "She is a really nice boat." ■



# Jack Heads to Alaska SE

## Right place! Wrong boat? Wrong attitude?

BY DOUG PAINE • JACK • CAPRI 25 • SAN DIEGO, CA

As I continue to age (a situation I am not at all happy about), I have become quite aware that my days of adventuring are not unlimited. In 2014 I took my Capri 25 named Jack on the Singlehanded Transpac and earned the coveted belt buckle. At the time I had intended to do the race again in a more competitive and experienced way. But as time wore on, I began to think of all the other adventures I wanted to have. I thought about whether on my next adventure I wanted to wake each morning and see unlimited ocean, or whether I would rather see bears, trees, whales, and a multitude of little bays and inlets. The latter won out so I committed to taking Jack to Alaska.

As I prepared for the trip I began to realize how totally different the considerations for a blue water adventure like the Transpac were when compared to the coastal cruising I would be doing. First, my research succeeded in scaring the heck out of me with the talk of monster tidal currents, narrow passages, rocks, rocks and more rocks. There would be waters far too deep to anchor even a couple of feet offshore, weather that was highly unpredictable and dramatic, and forecasts that were often wrong or unobtainable. I needed to prepare for these challenges.

Power is always a concern of a small boat and my solar panels were not going to do the job in an area where it is only clear 20% of the time, so a Honda 1000 was brought aboard (it served well, and was run in conjunction with the outboard to minimize the noise nuisance).

Ground tackle became a really large consideration as my largest fear was of being caught in light or no wind in a tidal current too strong for my small outboard (a very used 2 HP Honda) with an anchor as my only fallback. Unlike offshore sailing, I was likely to anchor most nights or when I had adverse tides. I purchased a Mantus 13 lb. anchor and ground tackle based on the tests

I read and blogs I found of people cruising in SE. This sat in a Tupperware container lashed to the stern pulpit (I handle all anchoring from the cockpit as I usually sail singlehanded). I had read of people attempting to anchor with Danforths and plows failing because the anchor failed to penetrate the leafy seaweed, so I took an old Wilcox Crittenden yachtsman anchor as my stern anchor. It looked really salty on its bracket on the stern rail! I also had a Danforth 13S with its ground tackle in the locker (told you I was scared).

The other large project involved refurbishing an 80's vintage Avon Redcrest, an inflatable dinghy. I re-taped all the seams, built floor boards, replaced the rub rail, added new valves, and patched the worn parts. It served well as it folded up into a large sail bag for storage and, when half deflated, fit on the foredeck under the jib.

Most of the rest of the gear I got for the Transpac was suitable for the Alaska trip. I left the large life raft behind in favor of a small one man as a disaster was far more likely to occur near a shoreline on this trip. I used the Delorme for tracking and communication when in isolated areas to good effect. The AIS worked well.

For navigation I used a newly installed B&G Vulcan 7 (with a depth sounder, wind information, and speed transducer) in conjunction with INavX on both my iPad and iPhone. I have always been impressed by INavX (all charts downloaded free), but was disappointed in the Navionics Charts I purchased for the Vulcan as they lacked the detail I so needed when entering the small bays and inlets of SE (did I mention the rocks, there were rocks). I also used a new app to me called I-Boating which, while not having the detail of the other two, made point to point navigation easier because of its simplicity and easily identified navigation aids.

## **THERE REALLY IS ONLY ONE CRUISING GUIDE CONSIDERED THE GOLD STANDARD FOR CRUISING SE: EXPLORING THE INSIDE PASSAGE TO ALASKA, A CRUISING GUIDE FROM THE SAN JUAN ISLANDS TO GLACIER BAY BY DON DOUGLAS**

There really is only one cruising guide considered the gold standard for cruising SE: Exploring the Inside Passage to Alaska, A Cruising Guide from the San Juan Islands to Glacier Bay by Don Douglas. There are others, but talk to people cruising there and it always gets back to this one. It comes in at a whopping \$200.00 though (I bought an older edition from eBay for \$42.00 which served well as the bays haven't moved much in the last decade).

Preparations having been completed, my first task was to get the boat from San Diego to the nearest access Port Edward (2,241 miles) a few miles south of Prince Rupert. One of the upsides of having a small boat is its mobility. I had the option of hooking Jack up to our old but valiant Toyota Sienna (2006 with 237,000 miles), crossing my fingers and heading north (40 mph up the gradual hills, 20 mph up the steep ones). After three days of driving and 6 hours of sleep the 'War Horse' as she is affectionately known got Jack and I to Moore's Boatworks in Port Edward British Columbia.

I will not detail each leg of the trip, but I do want to convey the pattern that developed during the passages. After launching, my first challenge was to sail the 130 miles to Ketchikan so that I could clear customs. To get there you need to cross Dixon Entrance, which is exposed to the ocean at its western end and has a reputation for being rough and unpredictable, and then proceed to the Tongass Narrows which can have a tidal flow exceeding 12 knots. My anxiety level was pegging at 8 as I untied the dock lines. While Douglas guide listed a number of small bays and anchorages to duck into if necessary, there was so much that could go wrong. With the tides, the unpredictable weather, and the rocks (yep, rocks again) there might be little time with which to deal with a problem. This was in contrast to the Hawaii trip that allowed a sailor time to contemplate the next move and to develop a solution slowly (which I needed). As it turned

out I had a really good sail most of the way to Ketchikan with Dixon Entrance producing a 10 knot reaching wind, two delightful small bays providing scenic safe anchorages, and arriving at the Tongass Narrows at the start of the flood. This pattern of anxiety, followed by a successful passage, continued throughout the trip and was one of its defining qualities (more on that later). The anxiety proved to be justified however when I later got caught out in Chatham Strait in 35 knots of wind and a 7 ft. chop that came up in less than 15 minutes. Not a life threatening situation, but not fun either (though reaching with only a triple reefed main at 8 knots did have its upside). It was again justified while beating up the Behm Canal for 6 hours bucking a 30 knot wind off the nose and making a total of ten miles, which was just enough to get into the next safe anchorage before the tide turned.

But on the overwhelming plus side was what I saw and experienced was beyond anything I could imagine. I cannot even begin to convey the beauty that surrounds you everywhere you look. The enormity of power of the natural environment creates a sense of awe that is all encompassing and unparalleled. The land forms, the thousands of small bays and inlets, the changing water, the wild life, the mountains and streams, and the way the changing light plays on the land and water minute by minute leaves you staring around you at the unbelievable magnificence you are now a part of. Orcas swam within 7 feet of Jack, Humpback whales were seen almost daily, bald eagles sat on my masthead (breaking my Windex in the process).

My plans had been to get all the way north to Sitka and by day six we (my sister joined me for a week) had gotten to Thorne Bay. I was pushing hard but I was falling behind my schedule. I had planned to do about 50 to 80 miles per day, but it soon became clear that in my boat I could not buck the adverse tides. I had just gotten beat up



in the Chatham Strait. I felt over matched and out of place and I wanted to quit.

Fortunately Galen and I met two couples in Thorne Bay who took me under their wing and talked me through the ins and outs of cruising Alaska. There was nothing wrong with the boat they assured me, my difficulty came as a result of



my expectations and attitudes. I had blue water (or SoCal) expectations that the distance you traveled was controlled by the time you were willing to put in that day. If you wanted to do 100 miles at 5 knots you sailed and motored for 20 hours. Simple math. Not in Alaska. Alaska weather and water decide how

far, and where, you can go. You are not the decider. They taught me the mouse strategy for cruising. First you get all the weather information you can and then don't believe it. Second, if the weather information you don't believe looks favorable you poke your nose out to see if it is true. Then you scurry to the next safe bay or inlet and hide. They figured on traveling twenty miles in a day if the weather was good. Many days are likely to be spent just sitting tight, perhaps for days, waiting for favorable conditions. Galen and I decided to abandon the long distance involved in going to Sitka in favor of doing a 150 mile circle of Revillagigedo Island that would include going to the Misty Fjord National Monument. While

I never did get good at the mouse cruising strategy, having an ingrained desire to push hard for the next destination, it was a decision that led to an amazing days filled with challenge and beauty. The Misty Fjords have to be some of the most beautiful places on Earth.

I would be negligent to not talk about the hiking in Alaska SE. Each anchorage offers a stunning adventure exploring the shoreline, the lakes and hills with the added intrigue of running across grumpy grizzly bears. My sister and I took the boat back to Ketchikan after our circuit and flew to Sitka where she lives to meet my wife Connie. Connie is a hiker and so each day was filled with the sights sounds and beauty of the tropical forest. Waterfalls abounded, green was everywhere, the views were stunning.

I have learned quite a bit from this trip. I learned that I want to spend a good deal of time in SE when I retire (which now might be sooner than later). But not in Jack. I want to do it in a boat with a good sized diesel, a pilot house, and a heater (I plan to buy my son's Nauticat 33 when he upgrades). I want to work to be less compulsive and to slow down and appreciate the company I am fortunate enough to keep and the environment that surrounds me without feeling that I need to push on.

Most importantly I know there are still so many more adventures to be had. Alaska trips will certainly be part of those adventures, but for now the next one will consist of sailing Jack up the East Coast of the US through New England. That story will come after next summer! ■



### **Boomkicker®**

Boomkicker® boom supports are the simple solution to eliminate the topping lift along with the chafe, windage, hangups and adjustments. Proven durable and reliable, over 10,000 happy customers.

### **Easystow Fenders®**

The space saving solution for fenders. Stores flat, folded or rolled. Easy to inflate and tough.

Many sizes and uses, learn more.

*Practical Sailor rated "Best Choice"*



Manufactured in the US by SEOLADAIR LTD  
[www.boomkicker.com](http://www.boomkicker.com) or [www.easystowfenders.com](http://www.easystowfenders.com)  
**800-437-7654 • 708-482-8801**



# CELEBRATING THE CORONADO 15

**By John P. Eurich**

At the 2017 Coronado 15 North American Championship competitors, officials and volunteers took part in celebrating the 50th anniversary of the launch of the first Coronado 15 high performance sailing dinghy. We had a celebration cake, commemorative swag such as coffee cups, caps, tee shirts, awards, etc., had a group photo taken with all the competitors standing around the first C15, hull #1, and of course enjoyed the camaraderie. But something was missing. It was the man who put in the hard work to design and manufacture this wonderful boat. It was Frank Butler, President of Catalina Yachts, who, even though he provided 50th Anniversary Tee Shirts for all the competitors and volunteers, couldn't join us.

There was no way we were going to finish off this celebration without Mr. Butler, so we decided that if he couldn't come to us, we'd go to him. It took a while to get schedules to line up, but finally in September 2018, at the Westlake Yacht Club's Frank Butler Regatta, we competed with C15s and celebrated with Mr. Butler.

Gary Hughes, Westlake Yacht Club's Rear Commodore, put the necessary logistics in motion to get the visiting C15s launched in Westlake, and made sure the visiting competitors were taken care of. Vincent Paternoster put on a gourmet BBQ for all of us. We raced our C15s in what might be called light, shifty, variable and challenging winds, with Ole Eichorn and Beverly Burr taking 1st place.

Then came the highlight of the event: getting a photo with Frank Butler and the very first Coronado 15 dinghy, hull #1, first launched in 1967. Charlie Quest, rescued hull #1 in 2013 and restored her in time to race in the 2014 Coronado 15 NAC, and every NAC since.

Mrs. Butler said she remembered Frank putting in many long hours, sanding and shaping the mold for its hull. Thank you, Frank!

**50th Anniversary**  
Hull #1 celebrates 50 years while racing in the North American Championship



Frank Butler and Charlie Quest with hull #1, named "Grand Ole Gal" and labeled "1st in Class"

At the awards ceremony Frank Butler, his wife Jean, and their family joined us in continuing our celebration. Charlie Quest, Half Moon Bay Yacht Club's C15 Fleet Captain, presented the 50th Anniversary Commemorative Plaque to Frank Butler, which we'd been holding for over a year.



Frank Butler (seated), with the C15 competitors. LtoR: Clemente Rocha, John Eurich, Beverly Burr, Charlie Quest, Vincent Paternoster, Frank Butler, Bruce Fleck, Ole Eichorn (Photos by Jan Eurich)



# Tech Notes

Q&A for Your Catalina That's Been  
Factory-Approved for Accuracy

Tech Notes are also available at [www.mainsheet.net](http://www.mainsheet.net) in PDF format for printing or reading on digital devices. | Winter 2018 password: W364



## CATALINA 470 NATIONAL ASSOCIATION

### Copper Wiring Corrosion Alert!



C470 Association  
Technical Editor  
Joe Rocchio

Grandpa was having a grand time chatting with his very competent helmsperson, 8-year-old granddaughter Elena, as she steered Onward out of the anchorage near Lake Victoria in Elizabeth Harbor, Bahamas.

That's the excuse he gave for forgetting it was low tide and giving her the wrong course. So Onward did some "bottom

sounding" and had to wait until just after dark for enough tide to carry on to the night's anchorage off Sand Dollar Beach.

It was a pitch-black night and Onward was moving at idle speed when a powerboat approached from the starboard bow. I stopped Onward dead and exclaimed: "Gee it was just like they didn't see our starboard bow running light." Well, they hadn't. The Aquasignal Series 33 LED running light had picked that night to fail. The ensuing process of a simple fix/ replacement became very complex

and it uncovered a lurking problem that we all need to be aware of on our vessels: copper wire corrosion and embrittlement.

Following Simpletons Principle (it is usually the most basic thing that fails in a complex system), my initial assumption was that one of the crimp splices for the starboard running light had failed somewhere in the bow compartment. I started at the light itself to replace connectors and as I cut back the lead wire from the light, I could find no usable copper wire – all the way back to where the wires went into the

**Great Sailing ...**  
*with a lift!*

*Dinghy davits*  
*Outboard lifts*



*Discover the convenience...the security...  
the quality!*



(410) 269-1218 fax (410) 269-5230  
7416 Edgewood Rd., Annapolis, MD 21403

[www.katomarine.com](http://www.katomarine.com)

potting compound on the LED unit! As I attempted to strip the insulation, the wire disintegrated, leaving dull red powder and fragile red filaments behind. Even just handling the insulation caused the conductors to disintegrate. The positive lead was the most severely damaged but the negative lead also had no usable wire strands left. I then recalled that the port bow light had failed in a similar way a couple of years ago and had to be replaced.

I acknowledged a temporary defeat and ordered a new unit to be air shipped to Staniel Cay for me to pick up before crossing back to the US. As I began to install the new light, I discovered that the remainder of the power distribution wires in the bow compartment was damaged and unusable!

Power for the C470 bow running lights is supplied from the DC circuit breaker panel using two single 10-gauge wires. The wires run through the starboard soffit wire troughs to the watertight bulkhead of the anchor locker. There they penetrate the bulkhead through the waterproofing adhesive caulk along the deck joint. Inside the bow locker, the wires are spliced to two gray-covered dual conductor cables that then run up through the forward legs of the bow pulpit on the port and starboard sides to the running lights. These smaller diameter wires now needed to be replaced.

I retracted the two 10 gauge wires through the waterproof bulkhead so that the new connections to the distribution wires would be made in a protected area. When the insulation was stripped to apply the connectors, the wires exhibited some black corrosion on the outside surface of the strands. However, their diameter was large enough (and had a much lower surface-to-volume ratio) that neither their electrical carrying capacity nor mechanical strength had been affected in the bow compartment. I cleaned the wire surface with fine emery paper before crimping the connectors. It is important to note that all of the problematic wires were uncoated stranded copper; they were not tin-coated marine grade wire.

I installed a new terminal strip mounted in on the interior bulkhead. I then ran two runs of tin-coated 18-gauge dual conductor wire from the terminal strip, through the bulkhead,



behind the interior lip of the bow compartment deck, and then up the legs of the bow pulpit. This final run to the lights required removing the retaining screws from the legs of the bow pulpit. Then the forward legs were pulled out of the foot brackets. The caulking was then drilled out in the existing through-deck holes in the forward brackets.

Using a SS wire, new wire was snaked through the two forward legs. I used heat-shrink crimp butt connectors with heat-shrink overwraps for the final connection to the lights. The Aquasignal power wires are so small in diameter I had to first take ~0.75" of 20-gauge solid copper wire, bend them in half to form a tight "U" and solder them around the tips of the LED power leads to give enough size and mechanical strength for a good crimp connection. Working running lights! Nice!

So, what was going on? Copper is considered fairly stable in the marine environment - remember the use of copper sheeting for hull protection. However, in the presence of oxygen and moisture, copper can be oxidized. Chloride ions from the salt water environment can accelerate the process. The initial step when oxygen is somewhat limited (as in a wire covered with plastic insulation) is to form cuprous oxide,  $Cu_2O$ , which has a dull red matte color. The red surface coating as well as the powder and filaments on the corroded wires I found were due to this. With more oxygen (and moisture, time, heat) the more highly oxidized Cupric Oxide,  $CuO$ , is formed. The black coloring on the 10-gauge un-tinned copper wires was due to this.

But why the extreme degradation of the leads to the LED lights? NASA rigorously fights against dreaded "red plague" affecting the silver-coated wiring they use in their spacecraft electronics - formation of cuprous oxide. Beyond loss of strength and conductivity, this  $Cu_2O$  is a semiconductor and it can produce

So, what was going on?  
Copper is considered fairly stable in the marine environment...

other problematic electrical effects. Micro-flaws in the silver coating can allow moisture and oxygen to access the silver-copper interface setting up an electrochemical cell that produces  $Cu_2O$ . This leads me to the hypothesis that an electrochemical oxidation process is part of the problem I found and correlates with the positive power wire to the LED lights being degraded more than the negative wire. Moisture, oxygen, carbon dioxide and chloride ions are all present in the marine environment to act as accelerants.

For some reason, Aquasignal chooses to use very small gauge uncoated stranded copper wire for the power supply wires to their devices.

**World's Largest Selection of Catalina Sailboat Sails**



- Stock Sails
- Custom Sails
- Surplus Sails
- Roller Furlers
- Sail Covers



*Internet & Catalog Sales Since 1983*

**Complete Sail Inventory Online!**

*We guarantee the worlds largest selection of pre-made new sails for Catalina Sailboats in the world. Over 1000 new sails are on the shelf. Low Prices with convenient online shopping and fast shipping make sail replacement easy!*

- Discount Sail and Furler Packages
- Cruising Spinnaker Packages
- Lowest Prices on Roller Furling Units by: **CDI, Harken &**

Visit our Web Store:  
[www.thesailwarehouse.com](http://www.thesailwarehouse.com)

**The Sail Warehouse**

Dealer inquiries invited (831) 646-5346

**CATALINA 470 NATIONAL ASSOCIATION**

(continued from previous page)

The fine individual wire strands have lots of surface area to corrode and the thinner insulation is much more readily penetrated by oxygen and moisture. (Just think, a non-boating person probably got a value engineering award for this.)

Recommendations - First, spend the additional money for marine-grade tinned stranded copper wire on your boat. Second, beware of any small-gauge un-tinned stranded copper

wiring that may exist on your boat in high moisture level areas (e.g., anchor compartment, bilge, etc.). As most electronic equipment uses solid-state devices, manufacturers are moving to finer gauge wires for power connections to take advantage of the low power draw. These also have lower mechanical strength and are more difficult to work with. Just what we need! Third, have an emergency backup. As a result of this

problem, I built a temporary back up running light system using a set of nylon mounting clamps for 1" SS tubing with a mount for the portable LED running light "puck" I use on the tender. This device can display red, green, white, as all three colors as needed. The mount can be moved to where needed and the battery-operated "puck" used to provide a temporary running light. - **Joe Rocchio**, jjr@onward.ws

**Addendum to March 2018 Tech Note:**

In the March 2018 Tech Note, I related the saga of repairing the fractured plastic can of the Fischer-Panda generator's raw water filter. The fracture had occurred while attempting to re-prime the cooling water system with an external pump. Well, when I got to Nantucket this August to "jus chill", I started up the genset and found that it had again lost prime in the raw water cooling loop because the through-hull intake valve had been left open when sailing through rough seas. This time, I discovered that that the engine exhaust back pressure in the exhaust elbow can prevent the raw water pump from re-priming the system without some outside assistance to overcome the exhaust pressure. It's always something...



**The Natty Dodger**  
First in Quality, Design and Value



**GENCO Marine**  
Innovative canopy design for over 40 years

Visit [GencoMarine.com](http://GencoMarine.com)  
or call 1-800-361-2890 for a quote.



**STANDOUT**  
YACHT FITTINGS  
Custom Sunbrella Covers since 1980

**Winch Covers  
Lifesling Covers  
Grab Rail Covers  
Lifeline Cushions  
Stern Rail Cushions  
Anchor Windlass Covers  
and much more**

[standoutyachtfittings.com](http://standoutyachtfittings.com)  
1-800-622-1877

### What's that smell?!



C400 Association  
Technical Editor  
Olav N. Pedersen

We've all experienced it. Where's that smell coming from? Fortunately, the Midnight Sun has not had many issues like this. The bilge stays clean.

When I went to change out the plastic fittings to brass on the hot water tank, the hose line that goes down from the hot water tank underneath the floorboards was taut. So I unscrewed the floorboard that's located in front of the door to the trash compartment to see if I could create some slack. That's how I located the source of the smell.

Until this point in time, I was under the impression that there was a central bilge tank location (2 compartments connected by a conduit), which is just below the salon table. There is also a small collection point compartment that's about a foot higher just forward of the base of the mast, but I don't consider that part of the central bilge. My layout has the bilge pump in the aft compartment of the bilge and the A/C raw water strainer in the compartment forward of that. These two main compartments are connected by a conduit allowing the contents of the bilge to flow freely between the two allowing them to be pumped out. Well, that's what I thought.

What I was not aware of is that there are two (2) more bilge compartments aft of the two under the salon table that you can't see that are higher and drain forward.

That's right, there are four (4) compartments. It is also evident that, on my boat, no one has ever taken the floorboard up to inspect these two.

Both of the drain conduits in those compartments were completely clogged. Nothing was getting from the two aft compartments of the bilge to the two compartments under the table in the salon.

I went to the store and bought a thin plastic bristle brush and cleaned out the conduits. Then I cleaned out the compartments. While I was at it, I also cleaned out all drain conduits forward and aft. All was, once again, right with the bilge world.



Bilge Inspection Port

#### So, how can you check to see if you might have this problem without having to pull up the floorboard?

I found a simple way to check one of the compartments. There are two doors below and in front of the sink. Open the door on the left. Look down on the inside of the lower left corner and you'll see the opening where the hoses from the water heater go under the floorboard. You'll need a fairly high intensity flashlight to do this. Point it down that hole and you should see one of the bright, shiny stainless steel bolts and nuts that secure the keel to the boat (see photo). If you can't see that, you probably have a clog. If you can see it, but can also see standing water in it, it is clogged. I say that because these two hidden compartments are positioned higher than the other two, so, provided your bilge pump is working, they should completely gravitate to midship.

If you have to take the floorboard up, it's not a big deal and you will be amazed at what's under there! It's Grand Central Station for wires and hoses. It's also the ONLY way to access these two bilge compartments for a detailed inspection.

Hopefully, your aft bilge compartments are clear. If not, now you have a way to inspect one of them before you remove the floorboard. Ah, the joys of maintenance! **-Olav N. Pedersen**, olavnp@gmail.com

**CATALINA 36/375 INTERNATIONAL ASSOCIATION**

**Maker Movement and Catalinas from Leslie Troyer**



C36 Association  
Technical Editor  
Pre Mk II hulls  
Leslie Troyer

The “Maker Movement” has been going on for several years now with no sign of stopping. That doesn’t mean that most of us know what it is or how to take advantage of the new tools driving the DIY craze. The tools are coming available because of the advent of cheap surplus computers, motor controllers and Public Domain Software. 3D printers are the most visible of the new tools, but for this article I’m going to focus on the tool I’ve used to assist in customizing and fixing my Catalina 36 Mahalo, the CNC



C36 Association  
Technical Editor  
Pre Mk II hulls  
Chic Lasser

(Computer Numeric Control) Router. I have a Chinese CNC router purchased from eBay. I had to replace all the electronics on the router because they were neither reliable nor up to the quality I required. You can buy quality US made tools at most stores specializing in wood working tools.

One common step in the use of the CNC Maker tools is to model the thing to be made. This can be as easy as scanning a copy of what you need and processing it with several programs to convert it to something the CNC tool requires for machining. Advanced CAD/CAM modeling requires lots of training and practice. I’m not very fluent in CAD (my son can run rings around me), so I stick to fairly basic stuff, and don’t always take the easy path. For all the parts shown in this article I modeled the parts using CAMBAM; a low cost program that allows you to draft the part, then assign machining steps to various portions of the part. If all this sounds impossibly complicated – don’t worry – in most cities now there are “Maker” groups where you can go and get someone to make the parts for you. It might cost a few dollars, or taking someone for a ride on your boat, either

way, these tools can help you make things easier and more precise than possible with hand tools. Note: Some libraries now have 3D printers to use.

I’m going to describe different locations I’ve used or plan to use my CNC router on both my boat and a friend’s Cal-35 Cruiser. This should give you an idea of the capability and versatility of the tool.

**OOPS – The hole is too big**

Mahalo didn’t come with a propane alarm, but it did come with a propane stove that had no thermal interlocks on the gas flow. To fix that I purchased a Xintex propane alarm. The instructions said to cut a 2-1/16” hole for the control panel. A search of the stores resulted in lots of 2” and 2-1/8” hole saws but no 2-1/16”. Figuring that a gap of 1/32” around the alarm wouldn’t be bad I went for the 2-1/8”. Well it was bad, the flange on the control panel was so thin it wouldn’t seat correctly in the nice hole I already drilled. So I modeled up a bushing with a 2-1/16” inside diameter and an outside diameter that stepped from 2-1/8” to 2-3/16”. I cut the bushing out of a scrap of ABS black plastic I had laying around. If you look at it most people don’t even know I screwed up – just the way I like it!

**New Engine Panel**

Last issue showed a photo of the completed engine panel I made. While you can buy one from Catalina Direct, they are expensive and didn’t meet my needs. I had an ignition switch that wouldn’t fit in the standard panel, and I wanted additional and repositioned holes. Also my mounting holes are not symmetric and the standard panel would put mounting holes into empty space. Modeling the panel took several hours



and two attempts to get everything in the right place. The engraving is filled with white Gelcoat. If I was to do this again I would first paint the area with PVA (Polyvinyl Alcohol – mold release) so my coloring outside the lines could be washed away rather than smear the finished part.

**Electric Panel(s)**

My good friend with a Cal 35 Cruiser isn’t as lucky as us Catalina owners, we have Catalina Direct and the Catalina Factory to lean on for parts. As far as I know there is no one making parts for old Cals. His DC electrical panel consists of 6 circuit breakers. That may have been ok in the 1970’s when his boat was made but is inadequate in today’s environment. He can go to Blue Sea or make one himself but using CNC to fabricate the panel allows the use of buss bars and having things fit correctly without rework. Here the photo shows the modeling software in use. Accurate dimensions are available from vendors of all the major parts so the panel can be ready before any parts are ordered. Additionally several design iterations can be done with various switch layout with the printed result taped in place for usability studies. The panel has yet to be cut – a winter project. Les’s Tip: Be sure and enter the part number and manufacture of the items you’re modeling in the Notes area of the software – so if you need to make one for a friend later – you know what parts to order that will fit.

Like most of us I’m even running out of switch locations. Additionally I have both a masthead tri-color and standard bow/stern mounted nav Lights. It’s against COLREGs to run both at one time and I need to make it easy to select which set of lights I want to use (rough nasty weather goes to the masthead – otherwise bow/stern). I plan on making a plastic panel with small switches to select which nav lights I want to use as well as anchor and strobe. The router will cut switch locations, engrave switch usage, and engrave a boat outline from above cut holes for small LED’s that light up in appropriate locations so you can tell at a glance what the status of the required lighting is. Rather than use lots of connectors and wire to connect

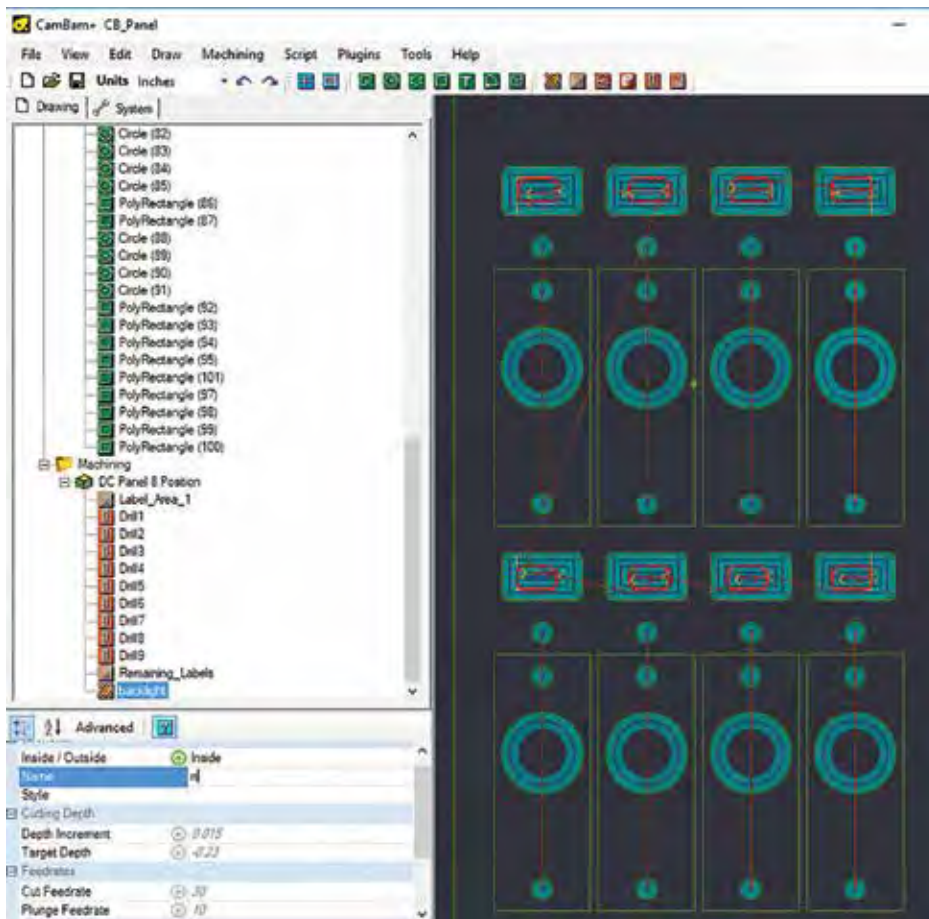

everything, I will use the CNC router to cut a simple circuit board and mount the switches and LED's as well as screw down connections for incoming and outgoing wires, more compact and reliable than using the standard wire and crimp connections.

### Cracked Teak

With Mahalo's age closing in on her length, some parts have seen better days. One example is the teak front on the sliding companionway hatch. Slamming it back and forth for 35+ years has caused cracks at the stress points. Teak is now almost \$30 / bd-ft, and fabricating the teak: cutting, profiling, is a lot of work - I know I used a piece of Iroko to replace it and while it looks ok - it doesn't fit in with the age and character of the boat. So I used a common wood working technique to stabilize the crack and at the same time give it character. This technique is using "bow-ties" or "butterflies" inlaid across the crack to hold it together and give cross grain strength to that portion of the part.

In designing the bow-ties I made sure the radius of both the inside and outside of the bow tie was larger than

my cutting tool (1/8" diameter or 1/16" radius). Once I modeled one bow-tie I could use the tools in CAMBAM to stretch or shrink to yield a bigger/smaller one with very little work. I can use the same model to both cut the bow-tie and cut the pocket in the existing piece where it will be glued. To do this first I applied a profile to the bow-tie specifying that the cut should be on the outside. Then I used a pocketing tool to cut the female shape to receive the part. Les's Hint: when profiling the male piece I lied to CAMBAM and said I have a .120" diameter cutting tool and not the .125" tool that was in there. This causes the male piece to be cut 0.01" smaller allowing for it to be easily tapped into place. The male repair parts were cut from a scrap piece of teak salvaged from the bow roller of the Cal 35 (after I made 100's of hole plugs out of it),

the photo shows two sizes of bowtie being cut on the router. After routing the bow-ties cut free on the band saw. You can program tabs to hold the pieces and cut the bow-ties to the thickness of the wood, but I find routing them short and cutting them free is easier than cleaning up the tabs. The female portion of the bow-tie is cut 4/5 of the way thru the board. This gives the maximum amount of glue surface for securing the bow-tie to the piece to be repaired. I tried to center the tie on the crack and was a bit off on one. Les's Hint: Set the origin of the part to the exact center of the bow-tie - this allows easy placement on the boards, center the cutter over the crack where you want the bowtie and zero the X&Y start locations.

See the photo of the repaired part after a single coat of finish. The finished product looked good and fit with the



**CATALINA 36/375 INTERNATIONAL ASSOCIATION**

(continued from previous page)

character of the boat, that I removed the replacement panel I made and put the repaired part back on the boat. Alternating between big and small bow-ties is strictly artistic and has nothing to do with strength, though on the other end of the board I have just two small bow-ties stabilizing a slightly smaller crack.

**Other Ideas –**

There is no shortage of things that need clamping to rails, or the helm guard. I tried making some out of starboard and standard wood working tools. Saws and twist drills work fine, but using a hole saw was a disaster. Using the router to fabricate clamps from wood or starboard will be very easy with the CNC router. The clamps holding my cockpit table to the helm guard are looking a bit rough – I sense a project coming on...

Engraving wood and plastic is especially easy with a CNC router. Be sure

I hope this article has given you a glimpse into the Maker Movement to see applications to improve your boat.

and use an “open” font, with no lines thinner than the size of your bit, and no sharp corners. I had recently made an engraved set of door boards made of ipe and maple for my friend with the Cal-35 cruiser (not the Destroyer his boat was named after). I would never attempt this with hand tools given the hardness and splintering tendency of ipe.

The fabricated part doesn't have to be a permanent part of the boat. While helping install a new Lewmar V3 windlass on the Cal-35, the instructions came with detailed hole placement drawings, but no template. Using the CNC router to lay out all the holes on a scrap of 1/4” plywood really sped up

the work. In addition cut circle inserts with a 1/4” hole in the center for any hole you're planning on drilling with a hole saw. Now you have a place to start each and every hole even if using a hole saw. Everything fit the first time with no need to drill any of the holes bigger to accommodate mislocated holes.

**Conclusion**

I hope this article has given you a glimpse into the Maker Movement and you can see applications to improve your boat. I'd be interested in hearing what Maker Tools you're using and what you've made. **–Leslie Troyer, leslie@e-troyer.com**

**Catalina Direct Offshore Sails By Ullman Ventura**

Catalina Direct has 35 years of experience satisfying the needs of Catalina sailors.

Gary Swenson's Ullman Sails Ventura loft has specialized in quality sails for Catalinas since 1977.

Your support of Catalina Direct makes us the world's largest supplier of parts, upgrades and sails for Catalina owners.

This unique three way partnership yields the experience and sales volume necessary to provide custom quality sails at excellent prices.

A high performance shape is crafted using Gary's 37 years of sailmaking experience.

The latest sailmaking software insures his vision is translated into a beautiful three dimensional shape.

A computer driven plotter/cutter insures our shape is accurately cut from carefully chosen cloth.

Quality craftsmanship with attention to detail creates a beautifully finished sail you'll be proud of.

Call our friendly staff for personal help with your next sail order or visit us online at [www.catalinadirect.com](http://www.catalinadirect.com).



**Catalina Direct**

8 0 0 - 9 5 9 - S A I L

# Replacing Leaking Ports from Chic Lasser

There is one common thread most Catalina 36 owners have, and that is leaking Lewmar ports. Whether your boat was built in 1984 or 2006 it seems most of our boats suffer from this curse. We have had Spendin Time since 2001 and have been fighting this losing battle each season. I have tried replacing seals, digging out the vinyl gasket that separates the two halves of our ports and filling them with silicone, covering that gap with clear tape and bottles of Captain Trolley's leak sealer. And although I have had limited success with some of these attempts, the leak always eventually comes back, as do the towels left on the cushions when we leave the boat. OK, I've had it! Time to replace the ports with new ones.

Our boat is a 1995 MKII and we have the old style Lewmar ports with the two halves joined together on the vertical sides of the port. Poor design to say the least, in fact Lewmar actually changed the design sometime in the late 90's to a single seam at the bottom of the port. This spring I ordered 4 new ports from Mack Sails and Rigging and set out to replace the old ports with new ones.

**Removal:** Actually quite easy, remove the trim ring after removing the Velcro tabs that secure the pleated shades. Next you have the interior frame which is held to the outside of the port with 12 panhead screws. Measure each screw length and denote it on the frame (some will be 15mm, 20mm and 25mm). Before starting this project I ordered 60 20mm screws from

McMaster Carr since the ones supplied were only 15mm and I knew I needed longer screws.

Once screws were removed I went outside and put a piece of blue tape on the edge of each port (see Photo 1) so I would have something to align the new port with when installing. Next, take a putty knife and gently push it behind the port, break the bond with the bedding tape, have your assistant (wife) push outward from the inside and it's out. My boat ports were installed using bedding tape so I scraped it off and cleaned it up using acetone (carefully not to disturb the blue tape).

As a side note, in photo 2 you will see why my ports leaked all those years. If you look closely you will see daylight in the lower corner where the bedding tape never sealed. Fortunately, water never intruded into the layup the ports were cut into, but on one port I noticed a large void in the layup. See photo 3.

Before installing that port I made a batch of West system epoxy and tried to inject it into the void, after putting in 6 oz. of epoxy and still not filling the void (must have been huge) I made another batch and put in some West filler to thicken it up, this was then troweled into the remaining crack to seal it, let dry and sanded smooth.

## Installation:

For bedding the ports I used bedding tape which I bought from MainSail, their Bed-it Product got rave reviews on the web and worked well for my job. To do all four ports I only used one roll but



Photo 2

didn't know that when making the order so I have an extra roll for future projects. Take the exterior portion of the port out and put a layer of tape around the outside edge of the entire port. The bends were a little interesting to do and I ultimately put two layers on all bends just to make sure I got a good seal. Now take that portion of the port outside and set it into the cutout aligning it with the blue tape. Press hard and hold in place, my assistant (wife) would now come out and hold the port in place while I attached the inner ring of the port to the exterior section. If you remember I had you write down the length of each screw you removed from the old port, this was for a good reason. When putting the new parts together use the same length



Photo 1

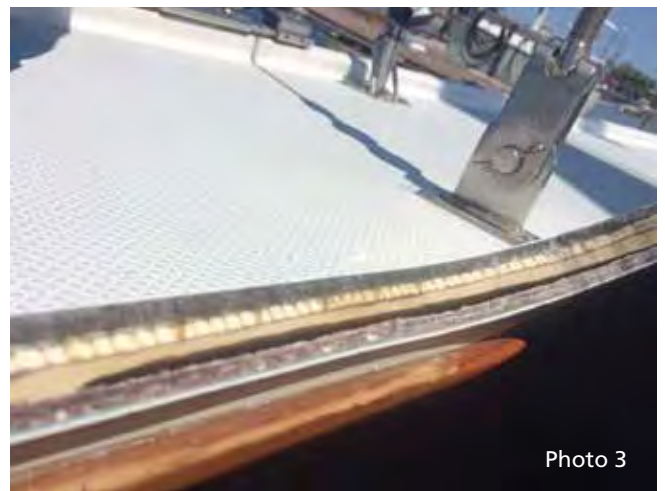

Photo 3

**CATALINA 36/375 INTERNATIONAL ASSOCIATION**

(continued from previous page)

screw as the old ports employed. If you didn't notice it when you took out the old port the thickness of the cabin roof is not consistent at all with it varying in some cases by 3/8". If you put too long a screw into the ports when you tighten it down it will come through the outside of the port so make diagrams and use the correct length screw.

Go outside when all screws are tightened and clean bedding tape off the cabin roof that had oozed out when tightening. Xacto Knives work well to cut the excess tape and acetone cleaned it off well.

The final step was installing the trim ring, which I felt was the hardest and most time consuming part. These ports come with two color choices of trim rings, white and beige. I thought ours were beige but in reality they were faded white ones, the beige looks great but were a bit darker than the faded ones. Use your old trim ring to get measure-



ments for cutting the depth of the new rings. I used a siding scissors to cut them but honestly it was a pain, after many cuts and recuts I got it perfect and reattached the rings with double stick Velcro like Catalina used on the originals. Once in place I reinstalled the Velcro dots for the shades with the original screws.

Repeat the process three more times and you are done. Happy and pleased to say we have NO LEAKS ANYMORE and the boat is super dry now. The total job took a few hours with it getting quicker as we got the system down. Now I wonder why I put up with those pesky leaks and towels all those years.  
**-Chic Lasser, chiclasser1@yahoo.com**

**DOYLE STACKPACK**



**OPEN AND SHUT CASE FOR EFFORTLESS FURLING**

- ⌘ Doyle StackPack is the ultimate mainsail furling system.
- ⌘ While sailing, the integral cover lies flat against the foot of the sail.
- ⌘ The StackPack's integral cover and lazy jacks neatly flake and hold the sail as it is lowered or reefed.
- ⌘ A StackPack can be added to your existing mainsail - your mainsail doesn't have to be new, and it doesn't have to be Doyle.

Visit us at [doylesails.com](http://doylesails.com)  
 or call 800-94-DOYLE



CALL US TODAY  
**401-847-7960**



**GORI PROPELLER**  
 experience the difference

Lowest drag, 100% reverse thrust. Unique overdrive.



The best rope, line & debris cutter there is!  
 Two piece, simple install.



Now 2X  
 More  
 Teeth!

**MOONLIGHT HATCHES**

High quality hatches & portlights.  
 Flush, compact, smooth design.



[sales@ab-marine.com](mailto:sales@ab-marine.com) | [ab-marine.com](http://ab-marine.com)

## CATALINA 350 INTERNATIONAL ASSOCIATION

### Where are we....?



C350 Association  
Technical Editor  
Bill Templeton

Before answering where we 350 owners are, let's look briefly at where we came from. The 350 – like all Catalinas – grew from owner feedback and input. Gerry Douglas put together a hull that provided the interior room of a 40 footer on a 31 ft 3 in waterline. March of 2003 Sailing Magazine described the 350 as not being an “oversized clone of it's predecessors but a true departure...” Huge interior volume, 13 ft beam, modest displacement and being “surprisingly nimble” for a boat of it's proportions. The introduction of the 350 did not go without dissent...some ultra-traditionalists slammed the design as being a floating condo not suited for offshore work. I will be the first to admit that the C36 may be a better sea boat but the extended time Pat and I have spent on Makani Kaicruising Long Island Sound and Chesapeake Bay we've been comfortable and always felt safe. As far as sailing ability, she's not a “gold plater” making to windward in an offshore race...but I have found a

clean bottom, Garhauer Easy Glides and paying attention I can keep up with some bigger boats...one time coming up from Atlantic City a C380 took six hours to catch and pass me only to discover he was motorsailing! We bought our 350 in Annapolis October, 2004 and took delivery in 2005. At the time the “base” price was substantially higher than the other “mass produced” boats of the same size...but by the time one added options to those others to equal what was standard on the Catalina (4 cyl diesel, 4D batteries, windlass, 11 gal water heater. etc.) the price difference disappeared...and we still had construction advantages such as the antimonious lead keel instead of cast iron.

Today, we get interested in other boats (C375 or C385) but don't find a difference in what we would do on the bigger boat over what we currently do with the 350...maybe Gerry shot himself in the foot by reducing the number of people who would move up from the 350. Recently I surveyed online yacht sales sources and compared asking prices of 2004-2006 Hunters. Beneteaus, C36s and C350s. The Hunters averaged \$86,435 ... Beneteaus \$86,600 ... C36s \$99,633...and the C350s \$114,414. This

being an indication that the C350 has held its value better than much of the “competition.”

Future...I would guess the C350 will continue to hold its value....with a modicum of care and maintenance will still provide comfort and safety, especially in coastal conditions. But we all begin to think of what will we do as we get older (I am “uncomfortably close” to 70...will there be a trawler in the future, I don't think so for quite awhile if at all. The 350 powers and motorsails well... all sail handling in the cockpit...maybe an electric winch or two. What about a bow thruster...some say that a thruster may not be needed; in most situations that may be true but in some high current areas (Point Judith RI, Delaware City DE) perhaps there would be a need. What follows is Robert Baker's install of a thruster in his 350.

Future entries will include SSB on the cheap (?), replacement of the waste valve, building and installing berth “fillers” to convert the “center-line queen” to a V-berth.

Keep those cards and letters coming.  
–Bill Templeton, pbtemp6816@verizon.net

### C350 Bow Thruster Project

After sailing an Allied Seawind 30 Ketch for nearly 20 years, we were fortunate to find an immaculate 2004 C350 at our marina after several years of searching for a new sailboat. The Seawind required heroic maintenance effort and I was spending less time on the water.

Migrating from a full keel, low freeboard sailboat to the C350 was a welcomed change in terms of amenities and cabin space, but the high freeboard/fin keel also made for some boat handling challenges, especially with high wind and current conditions. We wanted to be able to handle the boat confidently by ourselves in adverse conditions, especially in tight docking situations.

After researching bow thruster options with Pilots Point Maintenance Manager, Kip Wiley, we decided on a Side Power SE-60, single propeller unit, which they preferred for reliability and parts availability. We found the compartment under the V-Berth, between the anchor locker and forward water tank to have ample room for placement of the tunnel and thruster hardware.

(continued on next page)



**CATALINA 350 INTERNATIONAL ASSOCIATION**

(continued from previous page)

Since we had already converted to (4) Golf Cart batteries, we were able to avoid placing a dedicated battery in proximity to the thruster and ran large gauge cables from the battery compartment forward. The thruster is only used in short bursts and the main battery bank was sufficient. We installed a separate Power Switch in the battery compartment so that the thruster is powered off when docked. The more difficult job was running the control cable all the way aft and up into the Edson/Nav Pod, maybe more tedious than difficult. The simple control panel at the helm includes Power On/Off and two directional buttons.

After just one season, the value of the Bow Thruster has been proven. Jean and I can handle the boat in adverse conditions by ourselves. Even with other people on board, they often lack the experience to be very helpful or risk injury. The cost of professional installation was <\$10K, which when spread over the course of ownership made sense to us. I also looked at the potential cost associated with hitting a piling or another boat, and based on the increased peace of mind, felt that this was a good investment that would enable us to use the boat more. **-Bob & Jean Baker, C350 #167 Free Energy**

After just one season, the value of the Bow Thruster has been proven. Jean and I can handle the boat in adverse conditions by ourselves.



# Installation of a 'Below-Deck' Autopilot on a C34 MKII



C34 Association  
Technical Editor  
John M Nixon

C34 Associate  
Technical Editor  
Ron Hill

I hope everyone had a good summer, and those of us in Texas are hoping for a long fall and some good cooler (not cold...) sailing.

I am happy to say that we have a nice article in this edition from Graham Dodd, a UK resident and member of the C34AI. Graham tells me that he recently retired and now has

plenty of time to sail and do lots of projects on his 1997 C34 MKII. Hopefully we will be hearing more from Graham in the future! –**John Nixon**, Orta Vez; Hull #728, c34hull728@gmail.com

I purchased Smooth Jazz (1997 C34 MkII, hull #1376) in August 2004 as I thought it superior to many European yachts in that price range. After 14 years, I still hold this view. However in 2004 it came with an unreliable wheel autopilot and basic electronics. In 2005 I had all navigation electronics replaced with Raymarine equipment. I chose Raymarine because I have used them or their forerunner (Autohelm) since 1992 and enjoyed good service and reliability. The wheel pilot I chose was the ST4000 Mk2 model which was the strongest of Raymarine's wheel pilots; recommended for vessels up to 18,000 lbs. displacement; so should have been fine for Smooth Jazz at 12,550 lbs.

Smooth Jazz is based at Chichester on the South Coast of England and makes an annual voyage across to France and along the North Brittany coast; the voyage being approximately 500 miles. On many of these voyages, I encountered complete or partial failure of the ST4000 autopilot resulting in repair or replacement. In the summer of 2014, I again encountered a failure that required the unit being replaced. It was at this point that I decided to go for an up-grade, which meant a below-deck system.

After taking measurements in the aft lazarette, I found that I had insufficient space for the smallest below-decks Ray-



marine autopilot; this being their Evolution 'short-shaft' linear-drive system which was good for displacements of up to 24,000 lbs. The drive unit needed to be mounted on the strongest part of the stern, that being the underside of the aft boarding platform. The problem was that the aft water tank prevented full movement of a tiller arm (required for a below decks systems) when turning the boat to port. The only solution I came-up with was to have a section of the water tank cut away so that the tiller arm could move freely. The water tank would in any event, need to be taken-out in order to work on the rudderstock and the underside of the boarding platform.

**With some trepidation, the project began and the following is my programme of installation:**

### Equipment Purchased

1x Raymarine Evolution short shaft Autopilot system – product #T701581x  
Raymarine Rudder Reference Transducer – product #M811051x  
Raymarine Seatalk1 to Seatalk NG conversion kit – product #221581x  
Edson Tiller Arm – product #926-10-610MKII, bored to 2.86"4x  
Catalina polished flush-head drive mounting bolts – product #000531

a) Clear the decks: Removed all bedding and cushions from the aft cabin along with the aft wooden panel that traverses the cabin.



b) Cut the water tank: A 'cutting line' was drawn on the water tank sufficient to provide free movement of an Edson tiller arm. The water tank was then removed and sent to a specialist polypropylene fabricator. The re-fabricated tank was back in two weeks; I believe I have lost less than three gallons in capacity. [ Tech Ed note – The small cut-out at the left end of the new larger cut-out as shown in the picture is, I believe, what is left of the original 18" w x 5.5" d x 2.75" h cut-out designed to clear the Edson rudder radial drive-wheel. That may help you have a sense of scale. ]

c) Edson tiller arm: Product #926-10-610MKII, bored by Edson to 2.86". This was positioned just below the Edson steering radial drive-wheel. Integral clamp bolts were then tightened so that tiller arm was 90° starboard of the rudder position. Once absolutely sure we had the correct angle, the rudderstock was drilled and the tiller arm clamped and bolted.



d) Raymarine linear drive: The drive (product #M81130) was positioned on the starboard underside of the aft boarding platform so that the drive arm made a 90° angle to the tiller arm. Whilst there are a number of connecting holes on the tiller-arm that can be selected for the drive arm to attach, we wanted to position it towards the outer ones in order to obtain maximum leverage. Once a 90° angle was established, holes were then marked and drilled in the platform and the drive unit bolted with the Catalina Flush-head bolts – product #000531.

**CATALINA 34/355 INTERNATIONAL ASSOCIATION**

(continued from previous page)



e) Raymarine Actuator Control Unit: Product #E70099 was installed under the heads sink unit. Taking-out the locker doorframe provides better working access to install the ACU.



f) Raymarine Sensor Core: Product #E70096 was positioned in the starboard locker forward of the Holding Tank as we wanted to keep it clear of any electro-magnetic interference. Looking back, I think we were a bit over-cautious and this could have been installed below the head sink along with the ACU. [ Tech Ed note – With any sensor that contains magnetic sensing functions, constant vigilance is required to be aware of what is stored or located anywhere in close proximity to such a sensor that might be magnetic. A bit



of awareness of the surroundings can prevent lots of weird problems in a AP system sensor. ]

g) Install the Control Head: Product #E22166 merely was a replacement for the old ST60 control head used on the ST 4000 wheel unit. The STNG Adaptor Kit product #E22158 was installed within the instrument pod and is a simple ‘plug and play’ unit.

h) Rudder Reference Transducer: In addition, we used a Rudder Reference Unit Product #M81105 which while not essential, is recommended by Raymarine. Unfortunately, I did not find anywhere suitable to mount this, so I had to screw and glue a piece of marine ply to the underside of the cockpit deck; not great to look at, but it works and is out of sight below decks.

The Raymarine Evolution System #T70158 includes the drive, ACU, sensor core and control head. The system has a simple to use, dockside set-up procedure and hence it was soon working. Once we were satisfied with its operational status, we inserted and re-strapped the modified water tank along with the aft panel in the stern cabin; lastly a beer or two.

Three seasons later, I am extremely pleased with this Autopilot, as it is silent, reliable and simple to use. In 2016 my son-in-law (who also has a C34 MKII), installed the same system. Shortly afterwards he did a round trip of 3,000 miles from Chichester, UK to The Canary Islands off North Africa and was pleased with its performance.

**–Graham Dodd, Smooth Jazz #1376**

# Finding your Yanmar Engine Oil Leak



C320 Association  
Technical Editor  
Chris Burti

Special thanks to Troy Dunn for submitting this article.

—Warren Updike,  
wupdike@hotmail.com

The Yanmar 3GM30F fresh water-cooled engine installed on the Wonky Dog recently developed a minor oil leak. The Wonky Dog is a 1998 Catalina 320 manufactured in late 1997, Hull #514. Minor oil leaks can be notoriously difficult to hunt down, especially in the confined space that is typical of cruising sailboat “engine rooms.” Many of the leaks that develop appear first as nuisance leaks that are easily cleaned up with an oil absorbent material before it becomes an environmental hazard. However, some of these leaks are harbingers of potentially catastrophic losses in oil pressure that Murphy will undoubtedly schedule to happen at the worst possible time. It’s always best to try and eliminate these leaks as soon as they are discovered. This article describes some things a relatively handy sailor can do to attempt to identify and fix oil leaks. Some of these items are specific to the GM series of engines but some of these techniques could be applied to all engines.

### Obvious things to look at first.

Before you spend too much time worrying about the worst case scenarios, think about your experience and check off some of the easier things. Did you recently winterize, de-winterize, or top off the oil? Make sure the oil filter is hand tight. Make sure the oil fill cap and dipstick are properly seated. If there is oil on your bonnet (valve cover for you US folks) it could be that the O-ring beneath the cap got lost or is defective. These are all easy fixes and will save you the time and energy of more extensive procedures.

### Techniques for narrowing down the possibilities

Before you can begin to sort out your oil leak you need to do some homework. There are other resources you will want handy. The Operators Manual, Service



Manual, and the Parts Catalog for your engine which contains figures of all the engine sub-assemblies with all the part information. For the 3GM30F these items can be found on the C320 website under the “Resources” tab, “Reference Documents You should skim through the Parts Catalog figures to get a better idea of how the engine is put together. Anywhere that an item penetrates the block or seals the block is a possible leak path.

### Next Step, Start cleaning.

You will want to eliminate as much (if not all) of the oil and grime from your engine as possible. A simple clean rag will suffice. Start from the top and work your way down until you are ready to clean up the tray below the engine. The cleaner you get things the easier it will be to spot any leak paths. Pay close attention to cleaning around all those areas you saw in the parts catalog figures that might leak. Oil tends to gather at the rear base of the oil pan. That doesn’t mean your oil pan gasket is leaking although we can’t rule that out either. Once you are certain you’ve cleaned the entire engine to the best of your abilities and the tray is clean, put down some preferably white paper towels in the tray so you can see exactly when and where the oil is leaking. Do

not start the engine at this point.

Before starting your engine, you want to take a break and let things sit overnight. If you return in the morning and you have no oil on your engine tray paper towel you now know that you did an outstanding job of cleaning the oil and grime off your engine. You also can be somewhat sure that the oil leak path is above the level of where the oil sits when the engine isn’t in use, and that the likely leak path requires the oil pump to be operating. Now is a good time to go over the engine and look for any leaks that just haven’t made it to the paper towel. Start at the top again. Work your way down looking for new oil on the engine. You may need to use a paper towel or tissue to actually spot the oil by swiping along areas that have potential. Are there oily areas where you are positive you cleaned earlier?

If you get through this point with no leaks you can start up the engine for a few minutes until the oil heats up a bit. As the engine comes up to temperature shut down and repeat the leak detection process again. You need to take your time and be thorough. It is possible however that you won’t be able to get absolute certainty this way. If you find a leak try to fix it and repeat the process. This may take a few iterations.

**CATALINA 320 INTERNATIONAL ASSOCIATION**

(continued from previous page)

**The usual suspects**

The GM series of engines is almost 40 years old. A search of the sailing forums out there reveals quite a bit of information regarding the potential sources of oil leaks. If the obvious items aren't leaking then you're probably going to want to pay attention to these usual suspect items.

**This is the order as they appear in the parts catalog which is available on the C320 website:**

*Lube Oil Sump – Figure 5*

The lube oil sump (aka oil pan) gasket is a potential leak but probably not the first place you want to look. Any oil leak will likely gather near the gasket and the oil pan. You really need to rule out a lot of other items before this gasket becomes suspect.

*Oil Breather Assembly Figure 9*

The Oil Breather is at the back of the Bonnet. It can start leaking for a variety of reasons including a clogged breather tube.

*Bonnet gasket Figure 18*

The Bonnet gasket or valve cover gasket.

*Bonnet knob O-rings Figure 18*

The three knobs that hold the Bonnet in place are sealed with an O-ring. If the knobs become loose from engine vibration then there could be a leak here. An oily bonnet is an indicator of this assuming the filler cap and oil breather is not your leak path.

*The Dipstick Assembly Figure 28*

The dipstick assembly is mounted to the engine just above the oil sump. If the screws are loose on this item then it is likely the gasket has failed and once it fails tightening the screws may not work.

*Lube Oil Pipe Figure 31*

The lube oil pipe is an external steel (and in newer engines copper) line that feeds oil to the cam bearings. It uses 4 banjo bolts that attach to the outside of the engine on the port, aft, and star-board side of the engine. If you discover corrosion on your external oil pipe and you think this might be your problem, I



would recommend replacement. This is one potential failure path that isn't super forgiving. If this pipe has developed a pinhole leak, the size of that hole could expand rapidly and it won't be too long before your oil pump pumps all of your oil into the engine compartment tray. At that point your pressure alarm will sound and you will have no choice but to shut down the engine immediately. Failure to heed the alarm will result in a seized engine fairly quickly, you won't buy yourself enough time with this approach to warrant having to repower your vessel. This is not a scenario you want to chance. Unfortunately, the routing of this pipe makes it extremely difficult to be certain you have a pinhole leak in this pipe without removing the pipe. For a detailed look at how to make this particular repair, please see the article on the C320 website.

*Fuel Feed Pump Figure 44*

Although the Fuel Feed Pump is actually part of the fuel system, due to the way it is designed and operates, it is also a potential source of oil leaks. The Fuel Feed Pump or fuel lift pump is designed to provide just enough pressure to move fuel to the fuel injector pump. It operates by a lever that rides on the camshaft which creates the pumping action required. The assembly is mounted just like the dipstick assembly and the gasket that is between the pump and the block may fail in a similar

manner, because of the vibration from the lever arm that is moving up and down at the speed of your rpms. If the gasket fails, you will have an oil leak at this location. For a detailed look at how to make this particular repair, please see the article on the C320 website.

The list above is not exhaustive, but it provides an approach to finding your oil leak. If the above items do not bear fruit you can keep working with the parts catalog and manuals eventually you will find the culprit. A couple articles for replacing the fuel lift pump and the lube oil pipe are available on the C320 web site. Hopefully more will become available as others make additional repairs.

To locate the related articles on the C320 website, choose "Articles" "Technical Articles" then search: "Yanmar 3GM30F Oil Leak" for this article "Yanmar 3GM30F Fuel Feed" "Yanmar 3GM30F Oil Line".

**–Troy Dunn, S/V Wonky Dog, Hull #514**



# CATALINA 30/309 INTERNATIONAL ASSOCIATION

## Helm seat



C30/309  
Association  
Technical Editor  
Max Munger

Special thanks to Andy for more helm seat ideas.  
-Max Munger,  
maxmunger@verizon.net

Here's another version of a helm seat for the mark I cockpit. Provides good support when heeled either tack. Any available weatherproof material and glue can be used. -Andy, jones2ar@hotmail.com

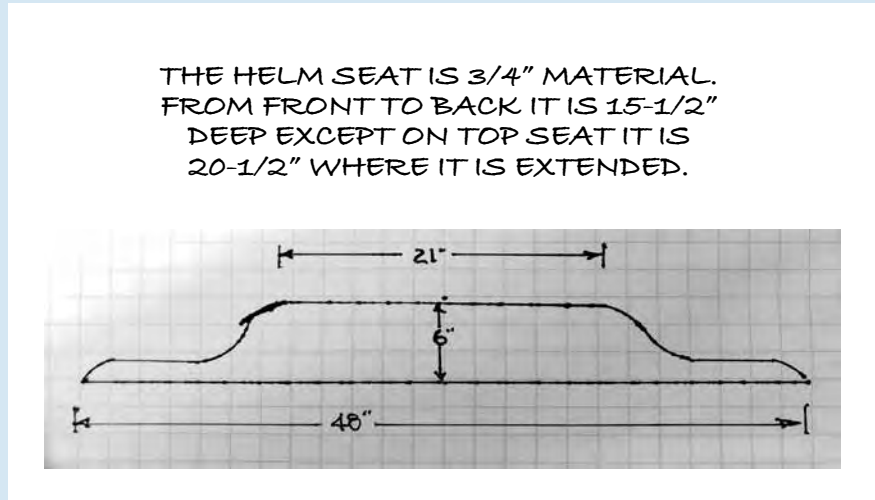

## MAINSHEET

Advertising

To reserve advertising space contact:

Jim Holder  
Phone (706) 951-4282  
Fax (706) 651-0533  
cv.jholder@mainsheet.net

Sails for Catalinas

## NATIONAL SAIL SUPPLY

Best sails for the money

You'll see the quality  
You'll feel the performance  
But most of all, you'll appreciate the price

Phone 1-800-611-3823  
Fax 813-200-1385

Email - NewSails@aol.com  
www.nationalsail.com

Order on the net

New and Used In stock

*Sailing doesn't have to be expensive*

## CATALINA 28 INTERNATIONAL ASSOCIATION

# Moisture Meters: Voo Doo or Science?

Many of us have been there, your search for hours, days and weeks for a new to you boat, you find it and after perhaps a brief negotiation the deal is stuck. We enter into that euphoria of feelings, joy, fear, anticipation day dreams of future adventures and even

C28 Association  
Technical Editor  
Ken Cox

arrange for a survey. You pay the yard bill and get the finished product with few surprises but then your

read “moisture indicated in laminate at xyz location”. Your feeling shift to fear, uncertainty and the thought of what does this really mean? Do I proceed? Throw good money after bad? Take the loss of the cost of the yard bill and survey and move on? Well, maybe?

Let's take a look at what a moisture meter is, what it can do and any limitations or caveats.

Originally they were used in the lumber industry and have been in use for almost 60 years. They come in two different types, some have pins that enter the substrate and others have pads that are non-invasive. Boat owners much prefer that you use the non-invasive type on their boat. I keep one of each and have used the pinned in an opened up suspect area.

The best thing to do with a meter is to use it, the more you do, the better you understand it. If you have never used one or had one used on your boat you are missing out on a way to stop what could be a very destructive issue with your boat that you have no idea until you sell it and get a huge surprise. An hour a year could save you not only a sale at sell time but also get you to do a small repair before it becomes a huge repair.

Think of it as a combination of ohm meter and radar. The meter send out a signal and determines content just like a depth sounder shows the bottom or a radar shows a fellow boater in the fog. The more of the electrical impulse that is returned the higher the moisture content is reads, i.e. higher percentage.

Take a piece of scrap plywood and give it a try, if your meter has multiple settings as does mine, it may have a setting for wood, masonry and maybe even drywall. Each has a different level of

sensitivity. In our example use the wood setting and take readings off of the plywood. Take them side to side and up and down. You now have a point of reference. Add just a few drops of water just in the center and then take readings across the board, see the increase. Now, you know it works.

Take another piece of wood and take your readings, write them down. Now back the wood with some metal, sheet metal, stainless, whatever, now take your readings again, see the difference? Now we are starting to learn what it all means.

If you use the same wood and read it in all the scales on your meter, you will learn what the most sensitive one is, but most likely the scale you will use will be wood, but if you have an area you are trying to pin point a place or origin a higher more sensitive scale may be helpful. What you are looking for is one area relative to another.

Now if you go to your boat and use say the wood scale, a good place to start, do a sketch of your boat's freeboard and take readings, up and down, working front to back, once you have done both sides, compare the readings. If areas are all pretty close you probably don't have an issue, but if you have a localized area of increase it is worth a closer look. Maybe there is a backing plate in the area, maybe a piece of equipment on the back side of that area, or maybe you even have a high level of moisture inside that needs to be addressed. Some caulks can also give a false positive. You can't know if you never look and if you look on a regular basis, keep your recorded numbers, you will know if something goes bad or changes.

Many things can give a false positive, even salt crystals that have dried, done too early in the day maybe dew on the deck, fresh or high copper content bottom paint or paint that has not dried out after a pull, even a very high temp or humidity day can effect the outcome, so always establish that base line or point of reference as it can change.

Normally, a high reading that tapers lower as you move away from it increases the likely hood of water in the substrate, but be sure you have eliminated all of the other possibilities.

Even with a high reading there is no guarantee there is a substantial amount of water in the laminate, only that this area is suspect. Also be sure to do a tap test in and around those area's to check for delamination, if the area fails both tests further investigation is warranted.

If further investigation is warranted, what type of core does the substrate actually have? If solid and it also fails the tap test, you most likely can remove the water and correct the delamination, same with a plastic core, but for foam or balsa a more invasive repair will be needed. For delamination of plastic it will continue to get worse as more water enters and it goes through the freeze/thaw process, for foam or wood cores you most likely will never get rid of the moisture content and make it solid again, oh, you may get it solid with enough epoxy but the wood is not really aiding it and in truth not doing what it was intended to do to reduce weight in the first place.

To actually know if there is damage inside, you can remove a station or hardware piece if one is close at it may also be the source of entry, you can also take a reading from inside to confirm and if all else fails you can open up a small area for a core sample.

Also look around thru hull fitting for discoloration and high reading in a circle around them as this can be an issue of electrical problems and that my friends is a whole new can of worms for another day.

So in the end if you buy a meter and continue to monitor you can save a small repair from turning into Godzilla and at the time you sell, you can have an explanation of a potential high reading if it has never changed. Use this in addition to your maintenance log and you will increase value at time of sell.

If you use a surveyor, ask him what type of meter he uses and how long or how many boats he as used it on as ultimately the skill of the person using it is of as great or greater value than the tool it's self and can make the difference between science and voo doo for you.

Hope this helps, **-Ken Cox**, kenneth\_cox@sbcglobal.net

## Catalina 28: From the Mail Bag

### HELPFUL HINTS FROM THE ONLINE GROUP FOR THIS QUARTER:

#### From Mike Smalter a quick way to reef when solo.

---

1. Put on autopilot.
2. Put the reef line on the port cabin winch
3. Let main sheet loose
4. Put one wrap of main halyard around starboard cabin winch
5. Release rope clutch for main halyard while holding halyard at winch
6. Grind port winch while letting the main halyard slip through your hand. Stop grinding when the reef point at the mast is at the boom
7. Close clutch for main halyard
8. Grind port winch till the aft (clew?) reef point is at the boom
9. Tension main halyard
10. Trim main sheet
11. Enjoy

#### From Gary Gamble, enlarging holes for new instrument installation:

---

Timely suggestion about using a backing board and hole saw to enlarge the hole for the instrument.

I just ordered a reconditioned i60 Wind to replace my old ST-50+ wind (still works but the masthead unit is for the newer models and reads 20% high and speed cannot be adjusted) and was thinking of using a dremel to enlarge the hole...backing plate and hole saw sounds much better.

Theoretically the i60 is electrically compatible and will work with both the original SeaTalk and SeaTalkNG. I'll let the group know how the install and new gauge works with my old gauges (ST-30 bidata for speed and depth, ST4000 autopilot). **-Gary Gamble**, Messalina MK-II 532, Mobile, AL

#### From Bob Thomas and Harry Fine, ways to route refrigeration lines in a new installation:

---

I installed a Vitrifrigo ND35CB4-QV auto-switching 12volt/120 volt in the aft berth port side bilge area compartment. It fits nice, is quiet and cool. It has ducted cooling but I didn't need to utilize it.

The standard lines were just barely long enough to reach without using the more expensive extension refrigerant lines. I used a S3-Q evaporator plate. It uses 3.4 amps while the compressor is running.

In California at 80 degrees ambient the compressor runs for 6 minutes and is off for 18 minutes with the thermostat set at 36 degrees.

I laminated aluminum mounts with rubber well nuts to the hull using West Systems G-Flex epoxy and glass matt

I purchased it from here... <http://www.suremarineservice.com/ND35CB4-QV.aspx> Ice Box <http://www.suremarineservice.com/Galley/Vitrifrigo-Boxed-Evaporators/S3-Q.html>

The ice box cooling lines were routed from the compressor in the port side aft berth compartment (under the mattress ) behind the head (accessible under sink in head) and through a hole I bored with a hole saw straight through the icebox wall to under sink area.

If you choose this method, drill a small (1/8") pilot hole first. I think I might have drilled from under the sink into the icebox to be sure it was located and concealed above the head sink door opening.

Be sure to insulate the lines well.

Because the cooling lines were only 6 feet plus what the compressor had, it was barely long enough to reach the ice box. I positioned the cooling box centered in the upper portion of the ice box. I made a stainless bottom for the cooling box and a starboard lid and it will freeze anything within the cooling box.

I mounted the cooling control where the cooling lines enter the icebox under the head sink area. **-Bob Thomas**, 1997 C28 MkII #498

#### From Harry Fine, looking for suggestions:

---

I bit the bullet and bought an ice box conversion to turn it into a fridge. It's a 2005 Catalina 28 MK II.

I read Tony Bacon's article in the files section, and searched for applicable threads. I'm still a bit confused about routing of the gas lines and wiring. In Tony's case there was a previous model, an Adler Barbour Cold machine icebox conversion already installed, and he simply followed the same route from the port side cockpit locker through the head into the ice chest.

But as I investigated and mapped out my route this afternoon, things don't line up. It seems pretty easy to get from the locker into the head. There is a space behind the cabinet in the head that hides wires/hoses/etc but continuing forward towards the bow, that channeling ends up in the electrical panel, a foot above the fridge..

So I'm looking for suggestions about how to get from the head into the side or back of the fridge. The fridge can't be pulled out, it's one integral piece of fiberglass with the port side dining area seating, so it's going to be a blind shot which I'm not happy about. Does anyone have any experience with this? **-Harry Fine**, Toronto, Canada, Hull 787, Wild Cat

**CATALINA 25/250 & CAPRI 25 INTERNATIONAL ASSOCIATION**

**C250 WB Trailer Modification**

C25 Association  
Technical Editor  
Seth Martin



C250 Association  
Technical Editor  
David Gonsalves

Capri 25  
Association  
Technical Editor  
Position Open

Special thanks to Henk and Johanna Grasmeyer from Langley, BC, Canada for this article about spare wheel and hitch extension.

**—David Gonsalves,**  
catalina250tech@  
catalina-capri-25s.org

As a native of Holland, I learned to sail at the age of six in a rowboat with oar and bed sheet. Later as a resident of Canada’s British Columbia, I owned a Hobie Cat for years. Then, several years before retirement, my wife and I

purchased Someday Lady, a trailerable 1995 Catalina 25 water-ballasted centerboard model, hull #151. As a way to transition into retirement, Johanna and I lived aboard for an entire year while cruising and trailering our boat around the continent from Vancouver via San Diego to Florida, north to Ontario and then through Ontario’s Trent-Severn Waterway from Lake Ontario west once again to Lake Huron’s Georgian Bay. We spent approximately half the time on water and half in RV parks and on the road. Someday Lady was our home, for that year as we followed the sun, covering more than 27,000 km or 16,800 miles. So that she could accommodate us comfortably, we invented, made, and added a variety of modifications. After owning the boat for 14 years in the spring of 2018 we sold the sail boat and obtained a 28ft power vessel with a triple axle trailer.

Have you ever travelled to and launched your boat at an unfamiliar rough, old, and dilapidated ramp and noticed that your trailer jack wheel was stuck, bent, or destroyed by the ramp’s grooves, cracks, or potholes? Perhaps you concluded that the ramp was too shallow for proper clearance of your keel and you needed a hitch extension to avoid backing the rear vehicle wheels into the water?

Our desire to be prepared after witnessing or hearing of problems such as these gave us the incentive to fabricate a simple 9-foot long sleeve hitch extension. Reversing the mounting arrangement of the trailer’s spare wheel gave us a substantial hitch jack and eliminated all ramp worries regardless of the condition.

We fabricated a 2-foot long 1/4- x 1/4- x 2 1/2-inch square inside diameter steel sleeve with welded extensions. This allowed it to be bolted to the underside of the trailer hitch beam. A standard 1/8- x 1/8- x 2 1/2-inch square outside diameter 10-foot long hitch extension fits inside the sleeve and is secured with a regular trailer pin inserted through the hitch sleeve.

By fabricating a 2 1/2-inch square inside diameter and 2 1/2-inch square outside diameter steel reversing Z-profile sleeve/insert mounting arrangement, the spare wheel is able to double as the trailer’s hitch jack. We remove the trailer pin, pull the tire from the sleeve, and re-insert it in down position. The wheel will now carry the weight of the trailer and boat while using the approximately 9-foot hitch extension. The hitch extension is equipped with its own hitch/ball arrangement.

Having launched and retrieved the boat in many locations and unfamiliar ramps during and after our year-long

wandering we did approach the job without apprehension of inadequate equipment. Launching and retrieving the boat remains a tense moment of our sailing experience and step for which you want to be well prepared.

Henk and Johanna fabricated a steel sleeve added to the trailer tongue to accommodate an approximately 9-foot hitch extension.

The sleeve is 2-feet long, 2-inch interior diameter square tubing with welded extensions to allow it to be bolted to the underside of the trailer tongue.

The tongue extension is a standard 2-inch outside diameter 10-foot long square tubing that fits snugly inside the sleeve and is secured with a standard cotter pin inserted through the hitch sleeve. To avoid rust, all parts are finished with several coats of cold liquid





galvanizing spray paint containing 95 percent self-sacrificing zinc.

The spare wheel doubles as the trailer's hitch jack. Remove the trailer pin, pull the wheel from the sleeve and re-insert it in down position. The wheel will now carry the weight of the trailer and boat while using the hitch extension. The extension is equipped with its own 2-inch hitch arrangement and stored, snugly next to the trailer's outside frame and trailer bunk uprights.

The arrangement with truck, extension, spare wheel in down position and the trailer build to accommodate a water-ballasted Catalina 250. Added parts are clamped and bolted to the trailer without welding. All standard black steel is finished, after degreasing, with several coats of cold liquid galvanizing which contains the self-sacrificing 95-percent zinc. Touch-ups are easy and make it look like new again. Liquid galvanizing spray cans are available in some paint, plumbing, lumber, or fence stores and cost less than \$20.

There is a slight (about 4-inch) curve in the hitch extension. This allows for the sharp downward curve in some ramps in the road leading to the ramp.

To simplify "backing up," Henk and Johanna installed a tow hitch package in the front of their vehicle. This took some of the stress out at unfamiliar and busy ramps as well as those with a long distance required for backing the boat.

**-Henk and Johanna Grasmeyer**, Langley, BC, Canada



There is a slight (about 4-inch) curve in the hitch extension. This allows for the sharp downward curve in some ramps in the road leading to the ramp. To simplify "backing up," we installed a tow hitch package in the front of their vehicle.

# Association News

News That's Specific To Your Catalina

## Catalina Fleet Rosters

We are printing one point of contact for each fleet (a phone number, email address, OR website address). Fleets are a great way to learn about rendezvous, cruise ins, raft ups, tours, and concerts in your area. *Mainsheet Editors, make sure to submit your current info in this format next issue!*

### CATALINA 36/375 FLEETS:

**C36/375IA Board Member, Fleet Relations**

[jblyth2@mindspring.com](mailto:jblyth2@mindspring.com)

**#1, Santa Monica Bay, CA**

[ginny.lechler@gmail.com](mailto:ginny.lechler@gmail.com)

**#2, Long Beach**

[mbierei@pirnie.com](mailto:mbierei@pirnie.com)

**#3, Chesapeake Bay**

[wjhomes@zoominternet.net](mailto:wjhomes@zoominternet.net)

**#4, Puget Sound**

[rodj2@msn.com](mailto:rodj2@msn.com)

**#5, Long Island Sound**

[tjl2000@optonline.net](mailto:tjl2000@optonline.net)

**#6, San Diego**

[dmumby3@cox.net](mailto:dmumby3@cox.net)

**#7, Lake Ontario**

[crew@ceibaone.ca](mailto:crew@ceibaone.ca)

**#8, New Jersey Coast**

[calypso36@comcast.net](mailto:calypso36@comcast.net)

**#9, San Francisco Bay**

[jennai1@sbcglobal.net](mailto:jennai1@sbcglobal.net)

**#10, Gold Coast (Ventura & Channel Islands)**

[jshapiro@kirkhill-ta.com](mailto:jshapiro@kirkhill-ta.com)

**#12, Punta Gorda, Florida**

[jblyth2@mindspring.com](mailto:jblyth2@mindspring.com)

**#14, Low Country (S. Carolina)**

[jblyth2@mindspring.com](mailto:jblyth2@mindspring.com)

**#15, Lake Texoma**

[jblyth2@mindspring.com](mailto:jblyth2@mindspring.com)

**#16, Texas Coast**

[jblyth2@mindspring.com](mailto:jblyth2@mindspring.com)

**#17, The Netherlands**

[e.scheffelaar@marineobjects.nl](mailto:e.scheffelaar@marineobjects.nl)

**NEW FLEET –**

**Lake Huron / Cheboygan**

[jenweber33@charter.net](mailto:jenweber33@charter.net)

### CATALINA 34/355 FLEETS:

**#1, San Francisco Bay**

[C34irvine1383@comcast.net](mailto:C34irvine1383@comcast.net)

**#12, Chesapeake Bay**

[fpoa34@aol.com](mailto:fpoa34@aol.com)

**#13, Lake Lanier Georgia**

[toneydot@me.com](mailto:toneydot@me.com)

**#14, Florida East Coast**

[bob@s-i-inc.com](mailto:bob@s-i-inc.com)

### CATALINA 30/309 FLEETS AND ALL CATALINA FLEETS WITH C30 MEMBERS:

**#1 San Francisco Bay, CA**

[www.southbeachyachtclub.org](http://www.southbeachyachtclub.org)

**#2 Marina Del Ray, CA**

800.501.1378

**#3 Long Island, NY**

<http://www.l-y-n-c-h.com/IC30F3>

**#4 Lake Erie, OH**

[jpaint412@msn.com](mailto:jpaint412@msn.com)

**#6 Seattle, WA Tacoma & South Sound, WA**

<http://home.earthlink.net/~catss>

**#7 Tampa/St. Petersburg, FL**

[AV8RSailor@verizon.net](mailto:AV8RSailor@verizon.net)

**#8 Long Beach, CA**

<http://www.cat30fleet8.com>

**#10 Galveston Bay**

[www.fleet10c30.com](http://www.fleet10c30.com)

**#11 Chesapeake Bay, MD**

[www.sailccyc.org](http://www.sailccyc.org)

**#12 North Atlantic (MA)**

[www.allcatalinane.org](http://www.allcatalinane.org)

**#13 San Diego, CA**

[www.sdcatalinaassoc.com](http://www.sdcatalinaassoc.com)

**#18 Long Island Sound (CT)**

[www.saillisca.com](http://www.saillisca.com)

**#19 King Harbor, CA**

[czamites@aol.com](mailto:czamites@aol.com)

**#21 Chicago, IL**

[www.catfleet21.org](http://www.catfleet21.org)

**#22 Puget Sound, WA**

[www.capsfleet1.com](http://www.capsfleet1.com)

**#24 San Pedro, CA**

[jerinbill@roadrunner.com](mailto:jerinbill@roadrunner.com)

**#26 Lake Texoma, TX/OK**

512.835.8680

**#27 Barnegat Bay, NJ**

(no contact)

**#28 Lake Ontario, NY**

[www.locac.com](http://www.locac.com)

**#29 Chelsea on Hudson, NY**

[salcerniglia@optonline.net](mailto:salcerniglia@optonline.net)

**#30 Hampton Roads, VA**

<http://fleet30.org/index.htm>

**#31 Clinton River, MI**

[drpost6290@yahoo.com](mailto:drpost6290@yahoo.com)

**#32 Lake Lanier, GA**

[rrose@deltaenv.com](mailto:rrose@deltaenv.com)

**#35 Southwest Florida**

(see Fleet #7)

**#36 Lake Perry, KS**

913.677.3143

**#37 Vancouver Island, BC**

[gm@bonnor.com](mailto:gm@bonnor.com)

**#38 West Michigan, MI**

<http://www.lmca.com/>

**#40 Lake Pleasant, AZ**

602.867.0650

**#42 Cheney Reservoir, KS**

[thegreenwoods@sbcglobal.net](mailto:thegreenwoods@sbcglobal.net)

**#44 Santa Cruz, CA**

[clubmanager@scyc.org](mailto:clubmanager@scyc.org)

**#45 Columbia, SC**

[szymanskim@msn.com](mailto:szymanskim@msn.com)

**#46 Grapevine Lake, TX**

[atanua.sail@gmail.com](mailto:atanua.sail@gmail.com)

**South Shore Yacht Club, Milwaukee, WI**

<http://2011c30anationalregatta.com>

**Other regional C30 Fleets**

**CRACA Columbia River, OR**

[celtic-myst@attbi.com](mailto:celtic-myst@attbi.com)

**KLACA Kerr Lake**

[doncourtney1@aol.com](mailto:doncourtney1@aol.com)

**OSCA Rhode Island**

[www.oscafleet.org](http://www.oscafleet.org)

**SBCYA Long Island, NY**

[www.sbcyc.org](http://www.sbcyc.org)

**CSMB Santa Monica Bay**

[millerjonathon@mac.com](mailto:millerjonathon@mac.com)

**Lake Hefner, OK**

[bluwater30@cox.net](mailto:bluwater30@cox.net)

**Fleet #69, Austen TX**

<http://www.catfleet69.com>

**GC3, Alabama**

[GulfCoastCatalinaCruisers.com](http://GulfCoastCatalinaCruisers.com)

Let us know where you sail!

To have your fleet listed here, send the information to your Association Editor for inclusion in the next issue.

## CATALINA 42/425 NATIONAL ASSOCIATION

### Tides and Seasons



C42/425  
Vice Commodore  
Jack Dunnigan

Tides run differently wherever you go. They come at different times of day. Some are large, some negligible. The same can be said about how we use our boats — we are all a bit different. Many of us are getting our boats put away

for the winter. For others, like Linda and I aboard our C425, Silver Girl, the season is just beginning. We live aboard and cruise from fall to spring in the Southeast and Bahamas, as we seek warmth and relief from snow, ice and the other parts of North Atlantic winter.

But there is also a constancy to tides. They ebb and flow almost twice each day in most places. And for our boats, the constancy is in the way that

these great designs support so many different types of sailing — from racing to cruising, weekends to live-aboards, back bays to ocean crossings. On the other hand, tides are predictable; but our sailing adventures are often less so.

The C42/425 Association, of course, is here to help all of us get the most out of the use of our boat, whatever our individual sailing patterns. From fix-its, to upgrades, to provisioning and destinations, we learn from sharing. Our owners' Facebook page is active, and the technical forum is a great place to help each other out.

The Association is going through a bit of changing tides itself at the moment. We have a number of roles that need to be filled, including Commodore. Folks willing to share technical skills could help to meet a particular need at this time. Website editing and domain management skills, and tech-

nical writing ability, would be especially helpful. Be sure to let us know if you would like to be part of supporting the owners and crews of these wonderful boats. Or let us know about some of your experiences on your boat. Drop a line to [info@catalina42.org](mailto:info@catalina42.org). We would love to hear from you!

And lift a toast to the changing of the tides, and the seasons; whether we be experiencing new adventures, or planning for our next ones!

—**Jack Dunnigan**, [info@catalina42.org](mailto:info@catalina42.org)

#### Our Officers:

Commodore: Jack Dunnigan, [dunniganlj@gmail.com](mailto:dunniganlj@gmail.com)  
Vice Commodore: Jack Dunnigan, [dunniganlj@gmail.com](mailto:dunniganlj@gmail.com)  
Secretary (Burgees): Mike Grove, [mgrove@gmail.com](mailto:mgrove@gmail.com)  
Treasurer/Mainsheet editor: Ken Fischer, [catalina42@mac.com](mailto:catalina42@mac.com)  
Membership Changes: Seth Martin, [Seth.martin@mac.com](mailto:Seth.martin@mac.com)  
Website Manager: Greg Hurt, [captcomocan@gmail.com](mailto:captcomocan@gmail.com)

## BETA MARINE

### RELIABILITY AND MORE!

More than just a reliable engine... all of our new engines are equipped with a serpentine belt drive system for the alternator at no extra cost!

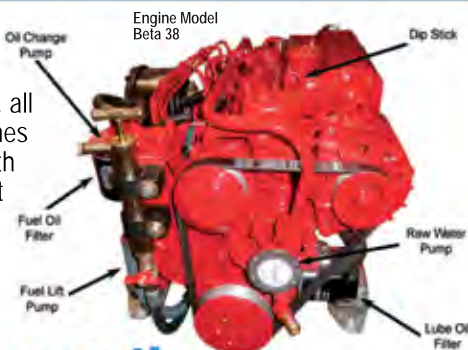

### What a concept! Engineered to be serviced easily

Marine engines using Kubota Diesels from 13.5 to 100 HP. Including Atomic 4 replacements and Saildrive engines.

Quiet diesels with clean emissions that meet current EPA requirements without the need for computer controlled common rail complexity.

#### BETA MARINE US Ltd.

PO Box 5, Minnesott Beach, NC 28510  
877-227-2473 • 252-249-2473 • fax 252-249-0049  
[info@betamarinenc.com](mailto:info@betamarinenc.com)

[www.betamarinenc.com](http://www.betamarinenc.com)

## The Natty Tarp

### Shrink wrap your wallet, not your boat!

Mast up or down, dinghy style, choice of door location, with or without frame — Genco custom fits your boat to best fit your needs and budget.



## GENCO Marine

Over 40 years of experience with expert staff

1008 Rangeview Rd.  
Port Credit 905-278-2891

1-800-361-2890

Please visit our website at  
[www.gencomarine.com](http://www.gencomarine.com)

**CATALINA 36/375 INTERNATIONAL ASSOCIATION**

**Commodore's Report**

As of the writing of this article, we are still transitioning to new oversight of the Association website. I am optimistic we can keep things running. If members are experiencing issues, please let me know.

We may also have some new officer blood soon, as I have had some interest in the Vice Commodore position. There is too much lag time between when I have to write this, but as with the website, I'm optimistic we will have a full Officer complement soon.



C36/375  
Commodore  
Laura Olsen

I am also pleased to report that our Association Facebook site continues to grow in numbers and more importantly, in overall enthusiasm about our boats and sailing.

We are approaching 600 participants! This represents a major shift in how sailors access and participate in the Catalina realm. I do not pretend to know where this will lead, however, it has become clear that our owners AND interested parties are actively engaging and helping each other.

As I write this, Hurricane Florence is bearing down on the Carolina coasts and our members are already offering help, in whatever form that may take. How cool is that!

I recall, or rather confess, there was some resistance to what FB and social media access might mean in the long run. At this point, I believe it is all good news. Membership at the Association website is up from the past few years. Fellow sailors seem to love the easy access of FB and sharing information. There is a genuine feel of enthusiasm for sailing in general and that can only be good.

Now that Fall is here and many of us are putting our boats up for the winter, it's time to settle in for winter. In between ski runs, this Commodore plans to read a bunch of books in the Patrick O'Brian series, make a boat project list, and attend a season of games with my Stanley Cup Champion Capitals. **-Laura Olsen**, safetsuper@gmail.com



Sunrise from my cockpit

QUALITY MARINE EQUIPMENT SINCE 1981

**KiwiGrip**  
Non-Skid Deck Systems

- Durable one part non-skid coating
- Adjustable texture
- Water based acrylic polymer
- Minimal prep work
- Covers uneven surfaces
- Easily tinted

KiwiGrip available through  
  
[www.catalinayachtsstore.com](http://www.catalinayachtsstore.com)

**MAX PROP**  
AUTOMATIC FEATHERING PROPELLERS

- Increase sailing speed by up to 15% while under sail
- 80% greater reverse power than a comparable fixed blade propeller
- Adjustable pitch
- Available in 2, 3, 4 or 5 blade versions

**PYI Inc.**  
 12532 Beverly Park Road  
 Lynnwood, WA 98087  
 425-355-3669  
 info@pyiinc.com  
 www.pyiinc.com

## CATALINA 34/355 INTERNATIONAL ASSOCIATION

### Secretary's Report

C34IA Membership increased modestly to 525 from last quarter's 513, and includes 33 C355s.

My second Canadian Catalina Rendezvous at Telegraph Harbor in mid-July was fun again. For those of you in the area, please put it on your calendar for next July (contact is sailorguyrob@gmail.com). Les on his Catalina 36, Mahalo, came up a few days ahead of time. We met at Bedwell and visited Winter Cove, Annette Inlet and Ganges before moving on to Thetis. Les presented his boat electronics workshop to the group.



C34/355  
Association  
Secretary  
Stu Jackson

The first week of August is the yearly Cowichan Bay Regatta, this year included the NA championships for M24s and multihulls. It is held in Satel-

lite Channel where there are usually reliable afternoon breezes. Morgan and I raised the mainsail, unfurled the jib, and sailed along the course, carefully avoiding the competitors. We were near the upwind mark when the M24 fleet popped their chutes. Later we were also close to the action for the upwind mark for the screaming multihulls. It was a fun afternoon and was great to be able to use both sails for the first time in a long time.

Later in August, friends Ken and JoAnn Cross, their daughter, Diana, and her dog, Fez, sailed up from Washington for a Gulf Island Tour to Otter Bay, Montague, Conover Cove and Thetis. Before, during and after, I continued my South Gulf Islands cruising, with weekly jaunts to now-familiar destinations.

It was a great "Second Season." Two Catalina Rendezvous, two cruises with friends gunk-holing through the islands, many weeklong local cruises, and viewing the yearly regatta.

This is the time to start planning for next season. Happy Holidays. And, as always, many thanks from all of us to all of you for supporting the C34IA.

—Stu Jackson

I raised the mainsail, unfurled the jib, and sailed along the course, carefully avoiding the competitors. We were near the upwind mark when the M24 fleet popped their chutes. Later we were also close to the action for the upwind mark for the screaming multihulls.

## CATALINA 310/315 INTERNATIONAL ASSOCIATION

### Greetings 310 and 315 Sailors



C310  
Commodore  
Alan Clark

We have had a great sailing season and hope you have also! Though our season was shorter than normal; at least it seemed that way since on the great lakes we only sail 6 months. As often happens – life gets in the way of sailing – and, during our sailing season we had obligations of family, grand kids and personal travel to Aruba and Havana Cuba. So, the shortened season. We have promised ourselves next year will be better !! and we mean it! We have done several sailing trips to Canada and the Erie Islands. We have also been out just sailing and Heaving

to. If you have never done it, that is a sailing skill to be accomplished. We have done some racing but mostly cruising. We did not have any major repairs this year and that is GREAT; we just get aboard our 310 and GO SAILING – but, not enough.

We have invitations to crew with friends racing which we will take advantage of, but sadly Anam Cara is going to her winter cradle to get shrink wrapped and winterized to be sailed again in April/May. Seems like a long time away but with sailing blogs/SBO forums/ friends who sail in the south. Hopefully will make the time go fast. Our goals next year will be to sail to new ports, introduce new people to our sport and re-acquaint those who have left to bring them back.

I am thankful for your 310/315 fleet staff who have graciously volunteered their time to work for you at my behest. None of us get paid, but Curt Sawyer, Bob James and Jesse Krawiec - who lives aboard his 310 in the Virgin Island - spend many hours helping all our 310/315 owners!

We hope everyone has a safe winter, hurricane season etc. See you on the water. —Alan Clark

We have done several sailing trips to Canada and the Erie Islands. We have also been out just sailing and Heaving to.

**CATALINA 30/309 INTERNATIONAL ASSOCIATION**

**Association Editor's Message**

As I write, it is only September, and there is a lot of sailing season yet to come. And the fall boat shows! Unfortunately, I will not be doing either one.



C30/309  
Association  
Editor  
Max Munger

Shermax has sat out a second summer with only a couple of sails and one race weekend. My arthritic knees don't like climbing over a sailboat any more. I am now considering selling Shermax after 38 faithful years!

I did compete in the 2018 Championship Regatta held in Chicago this August. See the separate recap article

provided by the host Columbia Yacht Club. It was a beautiful well officiated venue and a weekend in my (old) hometown. The two day Thunderbirds airshow overhead on the lakefront (Navy Pier) was an added bonus, distracting as it was. After five races, I hated to lose first place by just 10 feet, but the racing was that close all weekend.

I also have a regional convention that conflicts with the Annapolis Boat Show this Columbus Day weekend. Sad to say I will miss the show and Frank, Gerry, Sharon and the gang for the first time since 1973! Guess I won't be getting anything for Shermax this year. I will miss seeing all the C30 owners who come by the booth every year. And the great food and Painkillers!

The online move from Yahoo to Groups.io has went well. Membership and Mainsheet issues have been few and easily resolved by Seth Martin. Bad news is that membership is down to only 310 owners. A far cry from the 1500 in the 90's and the 2300 on the GIO list. The C309 group is integrated with the C30s now and all the photos, files etc are transferred. A wiki is slowly being filed in with materials from the owners on the new site. Unfortunately, little progress is being made on the website reincarnation. Anyone willing to help out? **-Max Munger**, maxmunger@verizon.net

**2018 Catalina 30 NCR Recap @ Columbia Yacht Club - Chicago**

By Michael Hettel • 309.256.3735 • michael.e.hettel@gmail.com

Perfect weather with blue skies all weekend, winds ranging from spirited to light, sea conditions from lumpy to flat and the annual Chicago Air Show complete with flying acts by the Air Force Thunderbirds greeted competitors for the 2018 Catalina 30 National Championship Regatta hosted by Columbia Yacht Club in Chicago Il. Three boats from Racine & Milwaukee joined Chicago based teams for the event. Only one spinnaker boat was registered, therefore, three jib and main classes were raced. Note that CYC boat Esther was being skippered by IC30A Treasurer Max Munger from Maryland and IC30A Secretary Richard Gunnell from Florida in the owners absence.



CYC Clubship Locale & Chicago Skyline

**Saturday Recap**

Seas were lumpy, 2-4 feet, given northerly breezes with the long fetch of Lake Michigan for several days prior to racing. Breezes were consistent in the 12-14 range with gusts to the upper teens. All in all making for some great spirited racing. Three races were easily completed, given the conditions. A fourth was considered, but ultimately the PRO opted not to, much to competitors' liking.

At the end of the first day of racing, Jam 2 section had only one point separating 1st (terrible Two's) and 2nd (Endurance) place boats. Same story in Jam 3 section with 1st (Esther) and 2nd (Ti Tae). Sunday racing was then a 'do or die' situation.

**Sunday Recap**

Conditions were much more conducive Sunday with a moderate chop of about 1 foot and breezes 6-9. The PRO announced two races were planned, a W/L and a Triangle. After the W/L, Jam 1 and Jam 2 section scores clearly determined the winners.

However, adding to the excitement of the day, Jam 3 top two boats, Esther and Ti Tae, were still tied with 6 points each. The last race would be for all the marbles, not to mention both are owned by ColYC members with a bit of a rivalry.

With Ti Tae taking the lead at the start, the plan was to cover and maintain the lead over Esther. However, Esther found more wind on the left side of the course, then Ti Tae died on the right side (where the greater pressure had been all weekend). With the lighter breezes all boats in all three

### Meltdown



### Terrible Twos



### Ti Tae



sections converged at the wing buoy, making for more tactical calls needed to race in the increased traffic.

On leg two of the triangle Ti Tae, and two other Jam 1 boats passed Esther forcing her to jibe away earlier than optimal. After a last jibe, Ti Tae controlled Esther by being between her and the finish line and with a half boat length lead. Ti Tae nosed over the line a mere half boat length ahead of Esther, to break the scoring tie and win Jam 3 section.

### Social Activities

Both the Saturday post-race party and dinner as well as the Sunday post-race awards ceremony and party/ buffet were held on the dock under blue skies. Awards were presented immediately after the Air Force Thunderbirds completed their overhead afternoon performances.

Two of the Wisconsin boats departed for home Sunday afternoon while the 3rd stayed at ColYC dock to depart Monday morning. The 'after party' continued at the club ship bar reliving the races.

### Results

#### JAM 1 (Spinnaker Trophy)

Meltdown (Michael Emery)  
Iset (Robert Moretti)  
Amazing Journey (Jack ORourke)

#### JAM 2 (Racing Tall Trophy)

Terrible Two's (Tom Vibbert)  
Endurance (Carolyn Rand)  
Irie (Lisa DeSantis)

#### JAM 3 (Racing STD Trophy)

Ti Tae (Craig Horton)  
Esther (Max Munger)  
Club Mel Too (Jonathan Bordoli)

# The Fastest Way To Get Downwind



## The Fastest Way Downwind On Your Catalina Is To Add A Whisker Pole To Your Jib or Symmetrical Spinnaker

If you need to get downwind and have a conventional non-planning hull, a jib with a whisker pole or conventional spinnaker are the fastest and easiest way to get to your destination. No need for the multiple jibe angles necessary with asymmetrical sails. Just point her deep downwind, hook up the pole and take a comfortable sail directly towards your goal.

### Aluminum • Carbon • 50/50 Combo

- Twist-Lock - For Boats 16 to 30 Feet
- Line Control - Premium Adjustable Length
- Tri-Reacher - Affordable Adjustable Length

World's #1 Whisker & Spinnaker Poles



22322 Gilberto, Rancho Santa Margarita, CA 92688  
949 858-8820 • www.forespar.com

## CATALINA 22 NATIONAL ASSOCIATION National Championship Regatta

The C22 National Sailing Association Board is buzzing with activity as we prepare for the 2019 National Championship Regatta next June 1 thru 6 on



C22 Association  
Editor Rich Fox

Fort Gibson Lake, in northeastern Oklahoma. The Notice of Race is now available on the Catalina 22 National Sailing Association's website at [www.catalina22.org](http://www.catalina22.org). To make sure that competitors

have a great racing experience, Hal Smith has agreed to be the PRO. Vice Commodore Duncan McBride has been on top of everything related to working with the TSA-LAGI Yacht Club and getting everybody engaged. And Secretary/Treasurer Dora McGee and Commodore Bill Heirendt worked with Catalina Yachts to make secure the really big Catalina 22

National Championship Regatta perpetual trophy will be on display.

Congratulations to Catalina Yachts for 50 great years of continuous production of the Catalina 22. You designed and built a fun boat that introduced tens of thousands of families to the enjoyment of sailing. What a wonderful accomplishment. In June 2019, The Catalina 22 National Sailing Association will celebrate this historic milestone at the Catalina 22 National Championship Regatta on Fort Gibson Lake, Oklahoma. Our goal is to get at least 50 Catalina 22s on the start line for this event. Whether you have a vintage Catalina 22, a Catalina 22 New Design, a Catalina 22 MK-II, or a Catalina 22 Sport, this event is open to all four models of Catalina 22s. We hope you will join us on Fort Gibson Lake next June 1-6 and help us celebrate 50 great years of Catalina 22 production...over 15,780 hulls built since 1969.



If you would like to learn more about the 50 year history of the Catalina 22, its builder, the class, and the people who love this boat, be sure to check out the publication *Catalina 22 - An All-Around Champion* that is available on the Associations' website.

### QUINTE CANVAS - Top Shop Inc.

*U.S. Sailors. Save an extra 20% off with the exchange rates.*



*Your Baby*



*Baby Blanket*

Keep your baby clean and dry this winter. Our 1" aluminum frames with Arctic Guard cover, installs in just a few hours. Mast up or down.

**(800) 268-4186**  
Kingston, Ontario Canada  
[topshop@quintecanvas.ca](mailto:topshop@quintecanvas.ca)  
[www.topshop.on.ca](http://www.topshop.on.ca)

**Universal Drink Holder**  
Holds all containers and fits all rails

**Companionway Doors**  
Replace your pesky hatch boards

**CloZures® Shutters**  
When Blinds and Shades just don't work

Free Sample

[www.zarcor.com](http://www.zarcor.com)

800-877-4797

972-380-8724

## CORONADO 15 NATIONAL ASSOCIATION

# 2018 Coronado 15 North Americans

By David Rumbaugh • 3699

In the early stages of planning, I was worried about the number of boats we might draw this year. Could we get people to travel up the “hill” to Huntington Lake, a lake about 90 miles east of Fresno, and at an elevation of about 7000 ft? If you have been to the lake before, you know the pure beauty of both the landscape and the sailing conditions. My fears started to subside with a couple of emails, one from Allison Jolly and one from Ole Eichhorn. With a combined 6 titles between the two the bar was raising quickly. Ole informed me that he would be sailing with another long time C15er, Jim Holder (lets add three more titles to the mix!). Then Vincent Paternoster registered with his crew Steve Miller (add another title to the mix). Another long time C15er, Charlie Heatherly, was coming back to the event as well and my excitement to be able to race against some of the top skippers/crews from the past was growing. Once it was all said and done, we had 18 crews registered with crews coming from SoCal, Sacramento, Half Moon Bay, Seattle, Oregon, Florida, and Georgia.

The Syd Corp series took place on Thursday with only 13 of the 18 boats on the line. Thursday would prove to be a challenge for everyone. Race one went off with a bang, tight racing all the way to the finish, I am talking about a finish after a 40-minute race that literally came down to an inch between Jim Holder and Charlie Quest. I was able to win the first race with Kary Sharp from Seattle in 2nd. Race two got a little scary on the run when the sky rumbled with thunder, but thankfully no lightning strikes to be seen. We were able to finish that race, but then racing for the day was quickly cancelled when more thunder moved in and rain, along with the wind going away. I had won the day with two bullets, followed by Kary Sharp from Seattle in second with 6 points (she won the tie breaker with Vincent Paternoster who also had 6 points).

Friday brought on a new set of challenges, all 18 boats would be on the line including Allison Jolly and



Charlie Heatherly, as well as the U20 fleet sailing in their PCCs. The weather also threw us a curveball, as the wind was about an hour late to arrive causing a postponement. Once the wind finally came up we were able to get in four

races. Tight racing allowed for three different race winners, with Steve Fishman and I winning races 1 and 3, Allison Jolly and Andrew Sumpton winning race 2, and Charlie Heatherly with crew Noah Farrell coming from behind on

**Advertising Index**

A.B. Marine ..... 28

Beta Marine ..... 41

Catalina Yachts Store ..... 10

Cruising Design, Inc ..... 8

Doyle ..... 28

Edson ..... C4

Forespar ..... 45

Garhauer Marine ..... C3

Genco Marine ..... 22, 41

Hamilton Ferris Company ..... 6

Kato Marine ..... 20

National Sail Supply ..... 35

PYI Inc ..... 42

Quinte Canvas ..... 46

Sail Warehouse ..... 21

Schaefer Marine ..... C2

Seoladair Ltd ..... 18

Standout Yacht Fittings ..... 22

Ullman Sails ..... 26

Yanmar ..... 5

Zarcor ..... 46

**MAINSHEET**

Advertising

**To reserve advertising space contact:**

Jim Holder  
 Phone (706) 951-4282  
 Fax (706) 651-0533  
 cv.jholder@mainsheet.net

**CORONADO 15 NATIONAL ASSOCIATION**

(continued from previous page)

the final leg of race 4 to edge us at the finish line for the win. The top three crews came out swinging and the first day saw us leading with 6 pts, Allison Jolly with 9pts, and Charlie Heatherly with 12 pts.

Saturday brought on a whole new set of challenges, with the final two days of our Championships running in conjunction with the Fresno Yacht Club's High Sierra regatta. Sharing the lake with 90 other boats would prove to be a challenge for everyone within our fleet. Not only would tactics play a role but keeping clear of the other boats ranging in size from Fireballs to an 11-meter would be a difficult task at times. With a little more breeze and some longer courses, Allison Jolly and crew Andrew Sumpton put the pressure on us all day long! We ended up winning the first two races of the day, and Allison put on a clinic in race 3 taking off from the rest of us for an easy victory. The scores after 7 races and a drop saw us in the lead with 8 pts, Allison in 2nd with 11pts, and after a very consistent day of all 3rd places finishes, Charlie H. and Noah had distanced themselves from the pack in a solid 3rd place overall with 15 pts. The battle was beginning for 4th – 8th place, with Chandler Sharp from Seattle, Mark Brazil from SoCal, Charlie Quest from HMB, Vincent Paternoster from SoCal, and Greg Krutzikowsky from Oregon all in striking distance with only 6 points

separating them all. Moving up the leaderboard into 5th overall with a couple of top five finishes was Mark Brazil and crew Alec Offenberge from SoCal.

Sunday dawned, and with 2 races left I needed a solid race one to put the title away, and with a little more breeze than the prior days, along with adding some rig tension to the boat, we were ready to go. Race one we instantly noticed better upwind pace and pointing and legged out to a solid lead. We were able to hold onto the lead all the way around, and with the race win the title was ours! Allison Jolly finished in 2nd, with Charlie Heatherly in another consistent 3rd place finish. While the top three boats seemed to be wrapped up, the battle was raging for 4th and 5th place between Mark Brazil and Chandler Sharp. These two boats had been battling it out all three days, typically finishing right next to each other. Even though Mark beat Chandler in the final two races, they ended up tied on points after the throw-out with 45 pts each. Chandler ended up winning the tie and the final trophy in the A fleet, a brand-new rudder cover!

All and all it was another fantastic event, an awesome venue, with fabulous people! I for one am looking forward to traveling to Seattle next summer for the 2019 edition of the North Americans!



# There is a Better Way...

*...don't tow it,  
Stow it!*

**G**arhauer's dinghy davits allow you to safely carry your dinghy to secluded anchorages. Forget about the hassle of towing a dinghy and all the potential problems that causes, not to mention the penalty of decreased boat speed.

Experience better performance in passage making and sleep better at night knowing your dinghy is secure.

All davits are made to order, based on the transom design and dimensions of your boat.

Davits are sold in pairs. Each davit arm is one-piece welded and polished stainless steel construction, built with the rock solid durability that all Garhauer hardware is known for.

Each davit arm comes complete with 6-1 purchase triple block system, including cam cleat, snap hook, 60' of line, along with cleat for fastening line. Included is stainless cross bar cut to length for your particular installation

## DINGHY DAVITS

*DD 6-1*

height 33"

arm length 36"

*DD 6-1, 1 in. tubing*

*DD 6-1, 1-1/4 in. tubing*

## DINGHY DAVIT ACCESSORIES

### *Davit Pivot Base*

For any angle transom mounting of arm, with backer plate.

### *Stern Rail Davit Clamp*

Clamps davit arm directly to 1" stern rail for lateral support.

**GARHAUER**  
MARINE HARDWARE

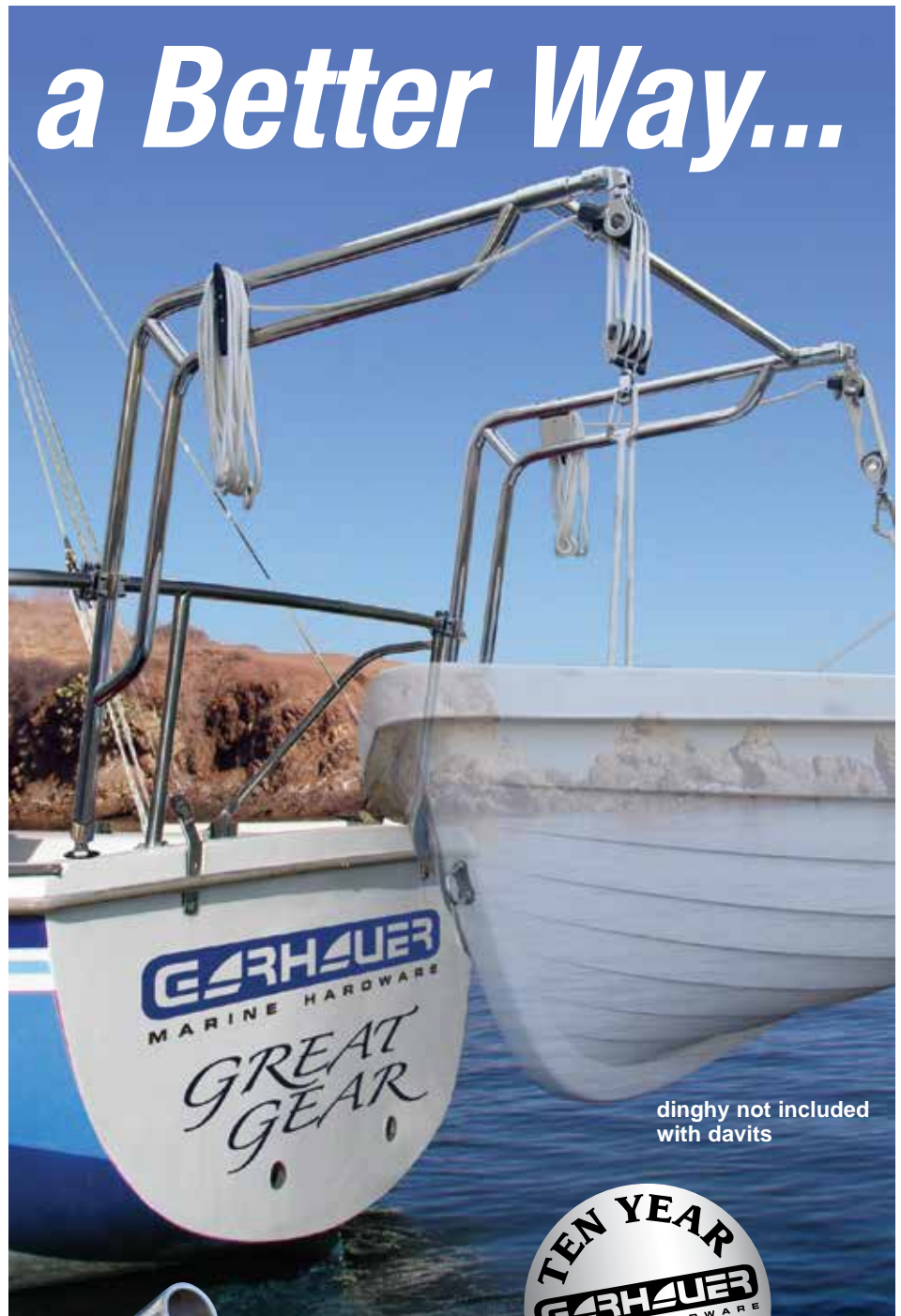

dinghy not included  
with davits



*Davit Pivot Base  
with backer plate*



*Stern Rail  
Davit Clamp*

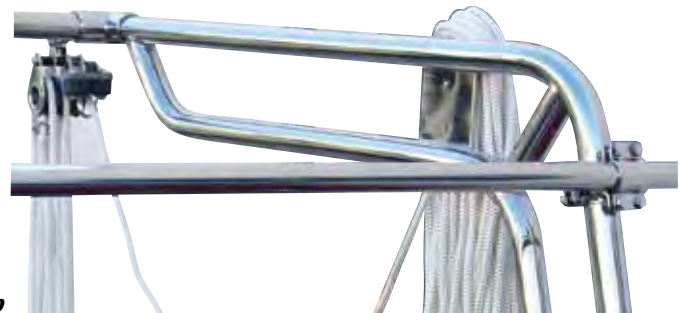

1082 West Ninth Street,  
Upland, California 91786

Phone: (909) 985-9993  
FAX: (909) 946-3913

email: [garhauer@garhauermarine.com](mailto:garhauer@garhauermarine.com)  
<http://www.garhauermarine.com>

# EDSON & Catalina Yachts

## Upgrade to the

### VISION II PEDESTAL



Steering  
Innovation  
and  
Excellence  
for over  
157 Years!



New Bedford, MA  
(508) 995-9711

[www.edsonmarine.com](http://www.edsonmarine.com)

Catalina Yachts Photo, By Billy Black

# Better By Design

Order online